



TRANE®

*Cooling and Heating
Systems and Services*

Installation Operation Maintenance

Series R™ Air-Cooled Helical-Rotary Liquid Chiller

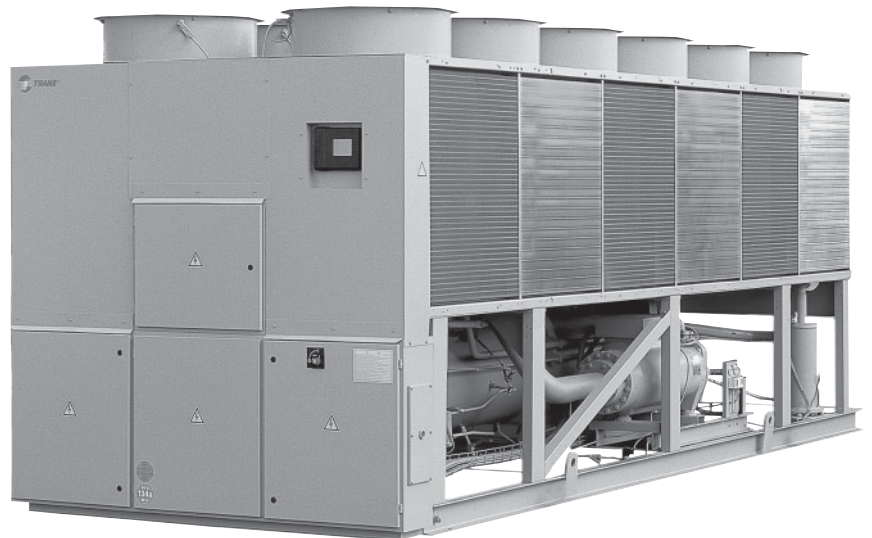

**Model RTAC 120-400 (50 Hz)
400-1500 kW**

RLC-SVX02G-E4

Contents

General Information	6
Unit Inspection	6
Loose Parts Inventory	6
General Data Tables	7
Installation - Mechanical	19
Installation Responsibilities	19
Storage	19
Special Lifting and Moving Instructions	20
Isolation and Sound Emission	21
Foundation	22
Clearances	22
Dimensional Data	23
Unit Isolation and Leveling	30
Neoprene Isolator Installation	30
Drainage	30
Evaporator Grooved Pipe	30
Water Treatment	31
Entering Chilled-Water Piping	31
Leaving Chilled-Water Piping	31
Evaporator Drain	31
Evaporator Flow Proving Device	31
Performance Data	32
Water Pressure Gauges	34
Water Pressure Relief Valves	35
Freeze Protection	35
Refrigerant Cutouts and Glycol Percentages	36

Contents

Installation - Electrical	39
General Recommendations	39
Wire Sizing	40
Electrical Data Tables	42
Installer-Supplied Components	46
Power Supply Wiring	46
Control Power Supply	46
Heater Power Supply	46
Water Pump Power Supply	47
Interconnecting Wiring	47
Alarm and Status Relay Outputs (Programmable Relays)	48
Relay Assignments Using TechView	49
Low Voltage Wiring	49
Emergency Stop	49
External Auto/Stop	49
External Circuit Lockout	50
Ice-Building Option	50
Optional External Chilled-Water Set Point (ECWS)	51
Optional Current Limit Setpoint	51
Optional Tracer Comm 3 Interface	53
LonTalk® Communications Interface for Chillers (LCI-C)	54
Operating Principles	55

Contents

Pre-Start Checkout 57

Installation Checklist	57
General	58
Unit Voltage Power Supply	58
Unit Voltage Imbalance	59
Unit Voltage Phasing	59
Water System Flow Rates	59
Water System Pressure Drop	59
Ch.530 Set-up	59

Unit Startup Procedures 60

Daily Unit Startup	60
General	60
Seasonal Unit Startup Procedure	61
System Restart After Extended Shutdown	61

Unit Shutdown Procedures 62

Temporary Shutdown And Restart	62
Extended Shutdown Procedure	62

Contents

Periodic Maintenance **63**

Maintenance Procedures **64**

Refrigerant Emission Control	64
Refrigerant and Oil Charge Management	64
Charge Isolation in the high or low side of system	66
Filter Replacement Procedure	68
Lubrication System	68
Prelubrication	70
Field Oil Charging Procedure	71

General Information

This manual describes installation, operation, and maintenance of RTAC units, manufactured in Charmes, France.

A separate manual is available for the use and maintenance of the unit's controls – Tracer™ CH.530.

Unit Inspection

On arrival, inspect the unit before signing the delivery note. Specify any visible damage on the delivery note, and send a registered letter of protest to the last carrier of the goods within 72 hours of delivery. Notify the local TRANE sales office at the same time. The delivery note must be clearly signed and countersigned by the driver. Any concealed damage shall be notified by a registered letter of protest to the last carrier of the goods within 72 hours of delivery. Notify the local TRANE sales office at the same time.

Important notice: No shipping claims will be accepted by TRANE if the above mentioned procedure is not respected.



Note: More stringent national rules can apply in some countries.

For more information, refer to the general sales conditions of your local TRANE sales office.

Figure 1 – Typical Unit Nameplate

TYPE ①			
	CRC	N° SERIE ②	CCYY
			N° ORGANISME NOTIFIE ③
	QTE-QTY	V / Hz / Ph	A max / FLA
			kw max
C1			
C2			
CONTROLE - CONTROL			VA
INTENSITE DEMARRAGE - STARTING AMPS			
FLUIDE ④		C1/C2	kg
		C1/C2	l
PS	BP-LP	bar	HP-HP
		bar	bar

① Type / Typ / Tipo / Tipo / Type / Tyyp / Type / Type / Tipo / Typ / Typ / Typ / Tipos / Τύπος
 ② Serial nb / Serienummer / Numero di serie / Numero de serie / Serienummer / Sarjanumero / Serienummer / Serienummer / Numero di serie / Tillverkningsnummer / Sé rovié číslo / Number fabryczny / Sorozat szám / Αριθμός σειράς
 ③ Notified body / Benannte Stelle / Organismo notificato / Organismo notificado / Bemyndiget organ / Autorizovaná osoba / Organizaція нотифікована / Registráció száma / Σόγια γυωσιστοιστήριος / Fluid / Fluide / Fluida / Fluidum / Fluidi / Stof / Kuldemedium / Fluido / Fluid / Kapalina / Czynniki / Козэг / peçenô
 ④

 **88130 CHARMES - FRANCE**
FOR TRANE BVBA 

Loose Parts Inventory

Check all the accessories and loose parts that are shipped with the unit against the shipping list. Included in these items will be water vessel drain plugs, rigging and electrical diagrams, and service literature, which are placed inside the control panel and/or starter panel for shipment.

General Data

SI Units

Table G-1 - General Data RTAC 140-200 Standard

Size		140	155	170	185	200
Cooling capacity (5) (6)	kW	491.9	537.3	585.4	648.0	714.5
Power input (7)	kW	170.1	187.8	206	224.7	244.2
Energy Efficiency Ratio (5) (6) (as Eurovent)	kW/kW	2.89	2.86	2.84	2.89	2.93
ESEER (as Eurovent)	kW/kW	3.68	3.68	3.61	3.43	3.67
IPLV (According to ARI conditions 44°F leaving water temperature, 95°F entering air temperature)	kW/kW	4.20	4.16	4.10	4.09	4.19
Compressor						
Quantity		2	2	2	2	2
Nominal Size (1)	tons	70/70	85/70	85/85	100/85	100/100
Evaporator						
Evaporator Model		EH140	EH155	EH170	EH185	EH200
Water Storage	l	112	122	127	135	147
Minimum Flow	l/s	13	14	13	14	16
Maximum Flow	l/s	44	49	46	49	55
Number of water passes		2	2	2	2	2
Condenser						
Quantity of Coils		4	4	4	4	4
Coil Length	mm	3962/3962	4572/3962	4572/4572	5486/4572	5486/5486
Coil Height	mm	1067	1067	1067	1067	1067
Fin series	fins/ft	192	192	192	192	192
Number of Rows		3	3	3	3	3
Condenser Fans						
Quantity (1)		4/4	5/4	5/5	6/5	6/6
Diameter	mm	762	762	762	762	762
Total Air Flow	m ³ /s	35.45	39.19	42.94	47.23	51.53
Nominal RPM		915	915	915	915	915
Tip Speed	m/s	36.48	36.48	36.48	36.48	36.48
Motor kW	kW	1.57	1.57	1.57	1.57	1.57
Minimum Starting/Operating Ambient (2)						
Standard Unit	°C	0	0	0	0	0
Low-Ambient Unit	°C	-18	-18	-18	-18	-18
General Unit						
Refrigerant		HFC 134a	HFC 134a	HFC 134a	HFC 134a	HFC 134a
Number of Independent Refrigerant Circuits		2	2	2	2	2
% Minimum Load (3)		17	17	17	17	17
Operating Weight (4)	kg	4481	4659	4794	5366	5488
Shipping Weight (4)	kg	4363	4411	4692	5257	5367

Notes:

1. Data containing information on two circuits shown as follows: ckt1/ckt2
2. Minimum start-up/operation ambient based on a 2.22 m/s (5mph) wind across the condenser.
3. Percent minimum load is for total machine at 10°C (50°F) ambient and 7°C (44°F) leaving chilled water temperature, not each individual circuit.
4. With aluminium fins.
5. At Eurovent conditions, 7°C leaving water temperature and 35°C entering condenser air temperature.
6. Ratings based on sea level altitude and evaporator fouling factor of 0.017615 m²/kW
7. Unit kW input, including fans

General Data

SI Units

Table G-2 - General Data RTAC 120-200 High Efficiency

Size		120	130	140	155	170	185	200
Cooling capacity (5) (6)	kW	421.9	465.9	513.3	557.3	603.7	669.8	740.1
Power input (7)	kW	137.5	151.4	165.7	182.7	200.3	219.1	238.7
Energy Efficiency Ratio (5) (6) (as Eurovent)	kW/kW	3.07	3.08	3.1	3.05	3.02	3.06	3.1
ESEER (as Eurovent)	kW/kW	3.80	3.82	3.83	3.84	3.74	3.53	3.80
IPLV (According to ARI conditions 44°F leaving water temperature, 95°F entering air temperature)	kW/kW	4.31	4.31	4.36	4.32	4.24	4.23	4.32
Compressor								
Quantity		2	2	2	2	2	2	2
Nominal Size (1)	tons	60/60	70/60	70/70	85/70	85/85	100/85	100/100
Evaporator								
Evaporator Model		EH140	EH155	EH170	EH185	EH200	EH220	EH240
Water Storage	l	112	122	127	135	147	146	159
Minimum Flow	l/s	13	14	13	14	16	14	16
Maximum Flow	l/s	44	49	46	49	55	49	55
Number of water passes		2	2	2	2	2	2	2
Condenser								
Quantity of Coils		4	4	4	4	4	4	4
Coil Length	mm	3962/3962	4572/3962	4572/4572	5486/4572	5486/5486	6400/5486	6400/6400
Coil Height	mm	1067	1067	1067	1067	1067	1067	1067
Fin series	fins/ft	192	192	192	192	192	192	192
Number of Rows		3	3	3	3	3	3	3
Condenser Fans								
Quantity (1)		4/4	5/4	5/5	6/5	6/6	7/6	7/7
Diameter	mm	762	762	762	762	762	762	762
Total Air Flow	m ³ /s	35.42	39.16	42.9	47.19	51.48	55.77	60.07
Nominal RPM		915	915	915	915	915	915	915
Tip Speed	m/s	36.48	36.48	36.48	36.48	36.48	36.48	36.48
Motor kW	kW	1.57	1.57	1.57	1.57	1.57	1.57	1.57
Minimum Starting/Operating Ambient (2)								
Standard Unit	°C	0	0	0	0	0	0	0
Low-Ambient Unit	°C	-18	-18	-18	-18	-18	-18	-18
General Unit								
Refrigerant		HFC 134a	HFC 134a	HFC 134a	HFC 134a	HFC 134a	HFC 134a	HFC 134a
Number of Independent Refrigerant Circuits		2	2	2	2	2	2	2
% Minimum Load (3)		17	17	17	17	17	17	17
Operating Weight (4)	kg	4461	4519	4529	5180	5431	6005	6117
Shipping Weight (4)	kg	4363	4411	4427	5071	5310	5885	5984

Notes:

1. Data containing information on two circuits shown as follows: ckt1/ckt2
2. Minimum start-up/operation ambient based on a 2.22 m/s (5mph) wind across the condenser.
3. Percent minimum load is for total machine at 10°C (50°F) ambient and 7°C (44°F) leaving chilled water temperature, not each individual circuit.
4. With aluminium fins.
5. At Eurovent conditions, 7°C leaving water temperature and 35°C entering condenser air temperature.
6. Ratings based on sea level altitude and evaporator fouling factor of 0.017615 m²K/kW
7. Unit kW input, including fans

General Data

SI Units

Table G-3 - General Data RTAC 120-200 Extra Efficiency

Size		120	130	140	155	175	185	200
Cooling capacity (5) (6)	kW	426.8	474.7	520.7	566.4	632.8	679.6	747.1
Power input (7)	kW	135.1	149.7	164.8	179.8	198.4	215.7	236.4
Energy Efficiency Ratio (5) (6) (as Eurovent)	kW/kW	3.16	3.17	3.16	3.15	3.19	3.15	3.16
ESEER (as Eurovent)	kW/kW	3.92	3.86	3.92	3.84	4.07	3.95	3.90
IPLV (According to ARI conditions 44°F leaving water temperature, 95°F entering air temperature)	kW/kW	4.41	4.42	4.42	4.40	4.50	4.43	4.44
Compressor								
Quantity		2	2	2	2	2	2	2
Nominal Size (1)	tons	60/60	70/60	70/70	85/70	70/100	100/85	100/100
Evaporator								
Evaporator Model		EH140	EH155	EH170	EH185	EH220	EH220	EH240
Water Storage	l	112	122	127	135	146	146	159
Minimum Flow	l/s	13	14	13	14	14	14	16
Maximum Flow	l/s	44	49	46	49	49	49	55
Number of water passes		2	2	2	2	2	2	2
Condenser								
Quantity of Coils		4	4	4	4	4	4	4
Coil Length	mm	4572/4572	4572/4572	4572/4572	5486/5486	6400/5486	6400/6400	6400/6400
Coil Height	mm	1067	1067	1067	1067	1067	1067	1067
Fin series	fins/ft	192	192/180	180	192/180	180/192	192	192
Number of Rows		3	3/4	4	3/4	4/3	3/4	4
Condenser Fans								
Quantity (1)		4/4	5/5	5/5	6/6	7/6	7/7	7/7
Diameter	mm	762	762	762	762	762	762	762
Total Air Flow	m ³ /s	37.21	42.22	41.58	50.66	54.83	59.11	58.22
Nominal RPM		915	915	915	915	915	915	915
Tip Speed	m/s	36.48	36.48	36.48	36.48	36.48	36.48	36.48
Motor kW	kW	1.57	1.57	1.57	1.57	1.57	1.57	1.57
Minimum Starting/Operating Ambient (2)								
Standard Unit	°C	0	0	0	0	0	0	0
Low-Ambient Unit	°C	-18	-18	-18	-18	-18	-18	-18
General Unit								
Refrigerant		HFC 134a	HFC 134a	HFC 134a	HFC 134a	HFC 134a	HFC 134a	HFC 134a
Number of Independent Refrigerant Circuits		2	2	2	2	2	2	2
% Minimum Load (3)		17	17	17	17	17	17	17
Operating Weight (4)	kg	4775	4712	4613	5351	5842	6307	6497
Shipping Weight (4)	kg	4677	4969	4969	4506	4506	4604	5069

Notes:

1. Data containing information on two circuits shown as follows: ckt1/ckt2
2. Minimum start-up/operation ambient based on a 2.22 m/s (5mph) wind across the condenser.
3. Percent minimum load is for total machine at 10°C (50°F) ambient and 7°C (44°F) leaving chilled water temperature, not each individual circuit.
4. With aluminium fins.
5. At Eurovent conditions, 7°C leaving water temperature and 35°C entering condenser air temperature.
6. Ratings based on sea level altitude and evaporator fouling factor of 0.017615 m²K/kW
7. Unit kW input, including fans

General Data

SI Units

Table G-4 - General Data RTAC 140-200 Low Noise Standard

Size		140	155	170	185	200
Cooling capacity (5) (6)	kW	465.9	508.8	554.5	614.3	677.9
Power input (7)	kW	178.2	196.1	214.9	234.3	254.6
Energy Efficiency Ratio (5) (6) (as Eurovent)	kW/kW	2.61	2.6	2.58	2.62	2.66
ESEER (as Eurovent)	kW/kW	3.64	3.53	3.51	3.49	3.56
IPLV (According to ARI conditions 44°F leaving water temperature, 95°F entering air temperature)	kW/kW	4.09	4.04	4.03	3.99	4.11
Compressor						
Quantity		2	2	2	2	2
Nominal Size (1)	tons	70/70	85/70	85/85	100/85	100/100
Evaporator						
Evaporator Model		EH140	EH155	EH170	EH185	EH200
Water Storage	l	112	122	127	135	147
Minimum Flow	l/s	13	14	13	14	16
Maximum Flow	l/s	44	49	46	49	55
Number of water passes		2	2	2	2	2
Condenser						
Quantity of Coils		4	4	4	4	4
Coil Length	mm	3962/3962	4572/3962	4572/4572	5486/4572	5486/5486
Coil Height	mm	1067	1067	1067	1067	1067
Fin series	fins/ft	192	192	192	192	192
Number of Rows		3	3	3	3	3
Condenser Fans						
Quantity (1)		4/4	5/4	5/5	6/5	6/6
Diameter	mm	762	762	762	762	762
Total Air Flow	m ³ /s	26.49	29.17	31.84	35.02	38.21
Nominal RPM		680	680	680	680	680
Tip Speed	m/s	27.5	27.5	27.5	27.5	27.5
Motor kW	kW	0.75	0.75	0.75	0.75	0.75
Minimum Starting/Operating Ambient (2)						
Standard Unit	°C	0	0	0	0	0
Low-Ambient Unit	°C	-18	-18	-18	-18	-18
General Unit						
Refrigerant		HFC 134a	HFC 134a	HFC 134a	HFC 134a	HFC 134a
Number of Independent Refrigerant Circuits		2	2	2	2	2
% Minimum Load (3)		17	17	17	17	17
Operating Weight (4)	kg	4481	4659	4794	5366	5488
Shipping Weight (4)	kg	4363	4411	4692	5257	5367

Notes:

1. Data containing information on two circuits shown as follows: ckt1/ckt2
2. Minimum start-up/operation ambient based on a 2.22 m/s (5mph) wind across the condenser.
3. Percent minimum load is for total machine at 10°C (50°F) ambient and 7°C (44°F) leaving chilled water temperature, not each individual circuit.
4. With aluminium fins.
5. At Eurovent conditions, 7°C leaving water temperature and 35°C entering condenser air temperature.
6. Ratings based on sea level altitude and evaporator fouling factor of 0.017615 m²/K/kW
7. Unit kW input, including fans

General Data

SI Units

Table G-5 - General Data RTAC 120-200 High Efficiency Low Noise

Size		120	130	140	155	170	185	200
Cooling capacity (5) (6)	kW	405.0	447.6	493.3	535.5	580.1	643.8	711.3
Power input (7)	kW	141	155.1	169.8	186.8	204.3	223.8	244.2
Energy Efficiency Ratio (5) (6) (as Eurovent)	kW/kW	2.88	2.89	2.91	2.87	2.84	2.88	2.91
ESEER (as Eurovent)	kW/kW	3.78	3.78	3.83	3.82	3.76	3.75	3.80
IPLV (According to ARI conditions 44°F leaving water temperature, 95°F entering air temperature)	kW/kW	4.32	4.31	4.39	4.33	4.28	4.25	4.35
Compressor								
Quantity		2	2	2	2	2	2	2
Nominal Size (1)	tons	60/60	70/60	70/70	85/70	85/85	100/85	100/100
Evaporator								
Evaporator Model		EH140	EH155	EH170	EH185	EH200	EH220	EH240
Water Storage	l	112	122	127	135	147	146	159
Minimum Flow	l/s	13	14	13	14	16	14	16
Maximum Flow	l/s	44	49	46	49	55	49	55
Number of water passes		2	2	2	2	2	2	2
Condenser								
Quantity of Coils		4	4	4	4	4	4	4
Coil Length	mm	3962/3962	4572/3962	4572/4572	5486/4572	5486/5486	6400/5486	6400/6400
Coil Height	mm	1067	1067	1067	1067	1067	1067	1067
Fin series	fins/ft	192	192	192	192	192	192	192
Number of Rows		3	3	3	3	3	3	3
Condenser Fans								
Quantity (1)		4/4	5/4	5/5	6/5	6/6	7/6	7/7
Diameter	mm	762	762	762	762	762	762	762
Total Air Flow	m ³ /s	26.46	29.13	31.8	34.97	38.15	41.34	44.53
Nominal RPM		680	680	680	680	680	680	680
Tip Speed	m/s	27.5	27.5	27.5	27.5	27.5	27.5	27.5
Motor kW	kW	0.75	0.75	0.75	0.75	0.75	0.75	0.75
Minimum Starting/Operating Ambient (2)								
Standard Unit	°C	0	0	0	0	0	0	0
Low-Ambient Unit	°C	-18	-18	-18	-18	-18	-18	-18
General Unit								
Refrigerant		HFC 134a	HFC 134a	HFC 134a	HFC 134a	HFC 134a	HFC 134a	HFC 134a
Number of Independent Refrigerant Circuits		2	2	2	2	2	2	2
% Minimum Load (3)		17	17	17	17	17	17	17
Operating Weight (4)	kg	4461	4519	4529	5180	5431	6005	6117
Shipping Weight (4)	kg	4363	4411	4427	5071	5310	5885	5984

Notes:

1. Data containing information on two circuits shown as follows: ckt1/ckt2
2. Minimum start-up/operation ambient based on a 2.22 m/s (5mph) wind across the condenser.
3. Percent minimum load is for total machine at 10°C (50°F) ambient and 7°C (44°F) leaving chilled water temperature, not each individual circuit.
4. With aluminium fins.
5. At Eurovent conditions, 7°C leaving water temperature and 35°C entering condenser air temperature.
6. Ratings based on sea level altitude and evaporator fouling factor of 0.017615 m²/K/kW
7. Unit kW input, including fans

General Data

SI Units

Table G-6 - General Data RTAC 120-200 Extra Efficiency Low Noise

Size		120	130	140	155	175	185	200
Cooling capacity (5) (6)	kW	412.7	459.2	501.7	548.8	611.8	657.1	718.7
Power input (7)	kW	135.1	149.7	164.8	179.8	198.4	215.7	236.4
Energy Efficiency Ratio (5) (6) (as Eurovent)	kW/kW	3.01	3.03	2.96	3.01	3.04	3	2.96
ESEER (as Eurovent)	kW/kW	3.96	3.89	3.92	3.99	4.15	4.02	3.88
IPLV (According to ARI conditions 44°F leaving water temperature, 95°F entering air temperature)	kW/kW	4.48	4.51	4.45	4.54	4.62	4.52	4.41
Compressor								
Quantity		2	2	2	2	2	2	2
Nominal Size (1)	tons	60/60	70/60	70/70	85/70	70/100	100/85	100/100
Evaporator								
Evaporator Model		EH140	EH155	EH170	EH185	EH220	EH220	EH240
Water Storage	l	112	122	127	135	146	146	159
Minimum Flow	l/s	13	14	13	14	14	14	16
Maximum Flow	l/s	44	49	46	49	49	49	55
Number of water passes		2	2	2	2	2	2	2
Condenser								
Quantity of Coils		4	4	4	4	4	4	4
Coil Length	mm	4572/4572	4572/4572	4572/4572	5486/5486	6400/5486	6400/6400	6400/6400
Coil Height	mm	1067	1067	1067	1067	1067	1067	1067
Fin series	fins/ft	192	192/180	180	192/180	180/192	192	192
Number of Rows		3	3/4	4	3/4	4/3	3/4	4
Condenser Fans								
Quantity (1)		4/4	5/5	5/5	6/6	7/6	7/7	7/7
Diameter	mm	762	762	762	762	762	762	762
Total Air Flow	m ³ /s	28.13	31.15	30.54	37.37	40.43	43.61	42.76
Nominal RPM		680	680	680	680	680	680	680
Tip Speed	m/s	27.5	27.5	27.5	27.5	27.5	27.5	27.5
Motor kW	kW	0.75	0.75	0.75	0.75	0.75	0.75	0.75
Minimum Starting/Operating Ambient (2)								
Standard Unit	°C	0	0	0	0	0	0	0
Low-Ambient Unit	°C	-18	-18	-18	-18	-18	-18	-18
General Unit								
Refrigerant		HFC 134a	HFC 134a	HFC 134a	HFC 134a	HFC 134a	HFC 134a	HFC 134a
Number of Independent Refrigerant Circuits		2	2	2	2	2	2	2
% Minimum Load (3)		17	17	17	17	17	17	17
Operating Weight (4)	kg	4775	4712	4613	5351	5842	6307	6497
Shipping Weight (4)	kg	4677	4969	4969	4506	4506	4604	5069

Notes:

1. Data containing information on two circuits shown as follows: ckt1/ckt2
2. Minimum start-up/operation ambient based on a 2.22 m/s (5mph) wind across the condenser.
3. Percent minimum load is for total machine at 10°C (50°F) ambient and 7°C (44°F) leaving chilled water temperature, not each individual circuit.
4. With aluminium fins.
5. At Eurovent conditions, 7°C leaving water temperature and 35°C entering condenser air temperature.
6. Ratings based on sea level altitude and evaporator fouling factor of 0.017615 m²K/kW
7. Unit kW input, including fans

General Data

SI Units

Table G-7 - General Data RTAC 230-400 Standard

Size		230	240	250	275	300	350	375	400
Cooling capacity (5) (6)	kW	769.7	857.9	850.9	947.2	1077.3	1191.6	1322.4	1451.4
Power input (7)	kW	263	293.6	293.4	330.5	370.2	418.9	458.8	498.4
Energy Efficiency Ratio (5) (6) (as Eurovent)	kW/kW	2.93	2.92	2.9	2.87	2.91	2.85	2.88	2.91
ESEER (as Eurovent)	kW/kW	3.94	4.17	3.82	3.86	3.94	4.10	4.14	4.18
IPLV (According to ARI conditions 44°F leaving water temperature, 95°F entering air temperature)	kW/kW	4.31	4.35	4.05	4.05	3.97	4.47	4.50	4.54
Compressor									
Quantity		3	3	3	3	3	4	4	4
Nominal Size (1)	tons	60-60/100	70-70/100	70-70/100	85-85/100	100-100/100	85-85/85-85	100-100/85-85	100-100/100-100
Evaporator									
Evaporator Model		EH270	EH270	EH250	EH270	EH301	EH340	EH370	EH401
Water Storage	l	223	223	198	223	239	264	280	294
Minimum Flow	l/s	20	20	17	20	22	22	24	26
Maximum Flow	l/s	71	71	60	71	77	80	87	92
Number of water passes		2	2	2	2	2	2	2	2
Condenser									
Quantity of Coils		2/2	2/2	4/4	4/4	4/4	4/4	4/4	4/4
Coil Length	mm	6401/6401	6401/6401	3962/2743	4572/2743	5486/2743	4572/4572	5486/4572	5486/5486
Coil Height	mm	1067	1067	1067	1067	1067	1067	1067	1067
Fin series	fins/ft	192	180	192	192	192	192	192	192
Number of Rows		3	4	3	3	3	3	3	3
Condenser Fans									
Quantity (1)		7/7	7/7	8/6	10/6	12/6	10/10	12/10	12/12
Diameter	mm	762	762	762	762	762	762	762	762
Total Air Flow	m ³ /s	60.09	58.27	61.21	68.7	77.29	85.88	94.47	103.06
Nominal RPM		915	915	915	915	915	915	915	915
Tip Speed	m/s	36.48	36.48	36.48	36.48	36.48	36.48	36.48	36.49
Motor kW	kW	1.57	1.57	1.57	1.57	1.57	1.57	1.57	1.57
Minimum Starting/Operating Ambient (2)									
Standard Unit	°C	0	0	0	0	0	0	0	0
Low-Ambient Unit	°C	-18	-18	-18	-18	-18	-18	-18	-18
General Unit									
Refrigerant		HFC 134a	HFC 134a	HFC 134a	HFC 134a	HFC 134a	HFC 134a	HFC 134a	HFC 134a
Number of Independent Refrigerant Circuits		2	2	2	2	2	2	2	2
% Minimum Load (3)		13	13	13	13	13	10	10	10
Operating Weight (4)	kg	8040	8040	7892	8664	9375	10684	11330	11929
Shipping Weight (4)	kg	7660	7660	7694	8441	9136	10420	11050	11635

Notes:

1. Data containing information on two circuits shown as follows: ckt1/ckt2
2. Minimum start-up/operation ambient based on a 2.22 m/s (5mph) wind across the condenser.
3. Percent minimum load is for total machine at 10°C (50°F) ambient and 7°C (44°F) leaving chilled water temperature, not each individual circuit.
4. With aluminium fins.
5. At Eurovent conditions, 7°C leaving water temperature and 35°C entering condenser air temperature.
6. Ratings based on sea level altitude and evaporator fouling factor of 0.017615 m²K/kW
7. Unit kW input, including fans

General Data

SI Units

Table G-8 - General Data RTAC 250-400 High Efficiency

Size		250	275	300	350	375	400
Cooling capacity (5) (6)	kW	876.9	978.5	1111.8	1227.8	1363.9	1501.3
Power input (7)	kW	289.8	321	360.2	407.2	446.9	486.9
Energy Efficiency Ratio (5) (6) (as Eurovent)	kW/kW	3.03	3.05	3.09	3.02	3.05	3.09
ESEER (as Eurovent)	kW/kW	3.84	4.00	4.08	4.09	4.13	4.18
IPLV (According to ARI conditions 44°F leaving water temperature, 95°F entering air temperature)	kW/kW	4.10	4.35	4.45	4.44	4.47	4.54
Compressor							
Quantity		3	3	3	4	4	4
Nominal Size (1)	tons	70-70/100	85-85/100	100-100/100	85-85/85-85	100-100/85-85	100-100/100-100
Evaporator							
Evaporator Model		EH300	EH320	EH321	EH400	EH440	EH480
Water Storage	l	239	258	258	294	304	325
Minimum Flow	l/s	22	24	24	26	27	29
Maximum Flow	l/s	77	86	86	92	97	105
Number of water passes		2	2	2	2	2	2
Condenser							
Quantity of Coils		4/4	4/4	4/4	4/4	4/4	4/4
Coil Length	mm	4572/2743	5486/3658	6401/3658	5486/5486	6401/5486	6401/6401
Coil Height	mm	1067	1067	1067	1067	1067	1067
Fin series	fins/ft	192	192	192	192	192	192
Number of Rows		3	3	3	3	3	3
Condenser Fans							
Quantity (1)		10/6	12/6	14/6	12/12	14/12	14/14
Diameter	mm	762	762	762	762	762	762
Total Air Flow	m ³ /s	68.66	79.95	88.54	102.96	111.55	120.15
Nominal RPM		915	915	915	915	915	915
Tip Speed	m/s	36.48	36.48	36.48	36.48	36.48	36.48
Motor kW	kW	1.57	1.57	1.57	1.57	1.57	1.57
Minimum Starting/Operating Ambient (2)							
Standard Unit	°C	0	0	0	0	0	0
Low-Ambient Unit	°C	-18	-18	-18	-18	-18	-18
General Unit							
Refrigerant		HFC 134a	HFC 134a	HFC 134a	HFC 134a	HFC 134a	HFC 134a
Number of Independent Refrigerant Circuits		2	2	2	2	2	2
% Minimum Load (3)		13	13	13	10	10	10
Operating Weight (4)	kg	8359	9718	10258	11973	12507	13185
Shipping Weight (4)	kg	8120	9460	10000	11679	12204	12860

Notes:

1. Data containing information on two circuits shown as follows: ckt1/ckt2
2. Minimum start-up/operation ambient based on a 2.22 m/s (5mph) wind across the condenser.
3. Percent minimum load is for total machine at 10°C (50°F) ambient and 7°C (44°F) leaving chilled water temperature, not each individual circuit.
4. With aluminium fins.
5. At Eurovent conditions, 7°C leaving water temperature and 35°C entering condenser air temperature.
6. Ratings based on sea level altitude and evaporator fouling factor of 0.017615 m²K/kW
7. Unit kW input, including fans

General Data

SI Units

Table G-9 - General Data RTAC 255-400 Extra Efficiency

Size		255	275	300	355	375	400
Cooling capacity (5) (6)	kW	898.7	998.2	1128.3	1290.0	1388.1	1516.8
Power input (7)	kW	283.5	318.9	355.9	408.2	444.9	481.5
Energy Efficiency Ratio (5) (6) (as Eurovent)	kW/kW	3.17	3.13	3.17	3.16	3.12	3.15
ESEER (as Eurovent)	kW/kW	3.95	4.01	4.13	4.15	4.22	4.23
IPLV (According to ARI conditions 44°F leaving water temperature, 95°F entering air temperature)	kW/kW	4.43	4.43	4.5	4.52	4.57	4.56
Compressor							
Quantity		3	3	3	4	4	4
Nominal Size (1)	tons	70-70/100	85-85/100	100-100/100	70-70/100-100	100-100/85-85	100-100/100-100
Evaporator							
Evaporator Model		EH300	EH320	EH321	EH440	EH480	EH480
Water Storage	l	239	258	258	304	325	325
Minimum Flow	l/s	22	24	24	27	29	29
Maximum Flow	l/s	77	86	86	97	105	105
Number of water passes		2	2	2	2	2	2
Condenser							
Quantity of Coils		4/4	4/4	4/4	4/4	4/4	4/4
Coil Length	mm	4572/3658	5486/3658	6401/3658	6401/4572	6401/5486	6401/6401
Coil Height	mm	1067	1067	1067	1067	1067	1067
Fin series	fins/ft	180	180	180	180	180	180
Number of Rows		4	4	4	4	4	4
Condenser Fans							
Quantity (1)		10/6	12/8	14/8	14/10	14/12	14/14
Diameter	mm	762	762	762	762	762	762
Total Air Flow	m ³ /s	69.41	83.14	91.46	99.8	108.2	116.4
Nominal RPM		915	915	915	915	915	915
Tip Speed	m/s	36.48	36.48	36.48	36.48	36.48	36.48
Motor kW	kW	1.57	1.57	1.57	1.57	1.57	1.57
Minimum Starting/Operating Ambient (2)							
Standard Unit	°C	0	0	0	0	0	0
Low-Ambient Unit	°C	-18	-18	-18	-18	-18	-18
General Unit							
Refrigerant		HFC 134a	HFC 134a	HFC 134a	HFC 134a	HFC 134a	HFC 134a
Number of Independent Refrigerant Circuits		2	2	2	2	2	2
% Minimum Load (3)		13	13	13	10	10	10
Operating Weight (4)	kg	9484	10180	10795	12217	13092	13784
Shipping Weight (4)	kg	9245	9922	10537	11913	12766	13459

Notes:

1. Data containing information on two circuits shown as follows: ckt1/ckt2
2. Minimum start-up/operation ambient based on a 2.22 m/s (5mph) wind across the condenser.
3. Percent minimum load is for total machine at 10°C (50°F) ambient and 7°C (44°F) leaving chilled water temperature, not each individual circuit.
4. With aluminium fins.
5. At Eurovent conditions, 7°C leaving water temperature and 35°C entering condenser air temperature.
6. Ratings based on sea level altitude and evaporator fouling factor of 0.017615 m²K/kW
7. Unit kW input, including fans

General Data

SI Units

Table G-10 - General Data RTAC 230-400 Low Noise Standard

Size		230	240	250	275	300	350	375	400
Cooling capacity (5) (6)	kW	728.9	798.1	806.6	897.6	1021.8	1127.2	1252.4	1375.8
Power input (7)	kW	271.9	309.6	306.7	344.6	385.7	437	478.5	519.6
Energy Efficiency Ratio (5) (6) (as Eurovent)	kW/kW	2.68	2.58	2.63	2.61	2.65	2.58	2.62	2.65
ESEER (as Eurovent)	kW/kW	4.06	4.13	3.63	3.89	4.02	4.34	4.37	4.44
IPLV (According to ARI conditions 44°F leaving water temperature, 95°F entering air temperature)	kW/kW	4.47	4.51	4.13	4.17	4.06	4.72	4.77	4.85
Compressor									
Quantity		3	3	3	3	3	4	4	4
Nominal Size (1)	tons	60-60/100	70-70/100	70-70/100	85-85/100	100-100/100	85-85/85-85	100-100/85-85	100-100/100-100
Evaporator									
Evaporator Model		EH270	EH270	EH250	EH270	EH301	EH340	EH370	EH401
Water Storage	l	223	223	198	223	239	264	280	294
Minimum Flow	l/s	20	20	17	20	22	22	24	26
Maximum Flow	l/s	71	71	60	71	77	80	87	92
Number of water passes		2	2	2	2	2	2	2	2
Condenser									
Quantity of Coils		2/2	2/2	4/4	4/4	4/4	4/4	4/4	4/4
Coil Length	mm	6401/6401	6401/6401	3962/2743	4572/2743	5486/2743	4572/4572	5486/4572	5486/5486
Coil Height	mm	1067	1067	1067	1067	1067	1067	1067	1067
Fin series	fins/ft	192	180	192	192	192	192	192	192
Number of Rows		3	4	3	3	3	3	3	3
Condenser Fans									
Quantity (1)		7/7	7/7	8/6	10/6	12/6	10/10	12/10	12/12
Diameter	mm	762	762	762	762	762	762	762	762
Total Air Flow	m ³ /s	44.55	42.82	45.6	50.95	57.32	63.69	70.06	76.43
Nominal RPM		680	680	680	680	680	680	680	680
Tip Speed	m/s	27.5	27.5	27.5	27.5	27.5	27.5	27.5	27.5
Motor kW		0.75	0.75	0.75	0.75	0.75	0.75	0.75	0.75
Minimum Starting/Operating Ambient (2)									
Standard Unit	°C	0	0	0	0	0	0	0	0
Low-Ambient Unit	°C	-18	-18	-18	-18	-18	-18	-18	-18
General Unit									
Refrigerant		HFC 134a	HFC 134a	HFC 134a	HFC 134a	HFC 134a	HFC 134a	HFC 134a	HFC 134a
Number of Independent Refrigerant Circuits		2	2	2	2	2	2	2	2
% Minimum Load (3)		13	13	13	13	13	10	10	10
Operating Weight (4)	kg	8040	8040	7958	8745	9473	10779	11436	12051
Shipping Weight (4)	kg	7660	7760	7820	8581	9296	10617	11279	11881

Notes:

1. Data containing information on two circuits shown as follows: ckt1/ckt2
2. Minimum start-up/operation ambient based on a 2.22 m/s (5mph) wind across the condenser.
3. Percent minimum load is for total machine at 10°C (50°F) ambient and 7°C (44°F) leaving chilled water temperature, not each individual circuit.
4. With aluminium fins.
5. At Eurovent conditions, 7°C leaving water temperature and 35°C entering condenser air temperature.
6. Ratings based on sea level altitude and evaporator fouling factor of 0.017615 m²K/kW
7. Unit kW input, including fans

General Data

SI Units

Table G-11 - General Data RTAC 250-400 High Efficiency Low Noise

Size		250	275	300	350	375	400
Cooling capacity (5) (6)	kW	838.6	940.9	1068.9	1179.3	1310.1	1442.3
Power input (7)	kW	299	328.3	368.9	415.6	456.6	498.1
Energy Efficiency Ratio (5) (6) (as Eurovent)	kW/kW	2.81	2.87	2.9	2.84	2.87	2.9
ESEER (as Eurovent)	kW/kW	3.89	4.12	4.20	4.44	4.46	4.53
IPLV (According to ARI conditions 44°F leaving water temperature, 95°F entering air temperature)	kW/kW	4.13	4.36	4.24	4.82	4.86	4.94
Compressor							
Quantity		3	3	3	4	4	4
Nominal Size (1)	tons	70-70/100	85-85/100	100-100/100	85-85/85-85	100-100/85-85	100-100/100-100
Evaporator							
Evaporator Model		EH300	EH320	EH321	EH400	EH440	EH480
Water Storage	l	239	258	258	294	304	325
Minimum Flow	l/s	22	24	24	26	27	29
Maximum Flow	l/s	77	86	86	92	97	105
Number of water passes		2	2	2	2	2	2
Condenser							
Quantity of Coils		4/4	4/4	4/4	4/4	4/4	4/4
Coil Length	mm	4572/2743	5486/3658	6401/3658	5486/5486	6401/5486	6401/6401
Coil Height	mm	1067	1067	1067	1067	1067	1067
Fin series	fins/ft	192	192	192	192	192	192
Number of Rows		3	3	3	3	3	3
Condenser Fans							
Quantity (1)		10/6	12/6	14/6	12/12	14/12	14/14
Diameter	mm	762	762	762	762	762	762
Total Air Flow	m ³ /s	50.91	59.78	66.15	76.32	82.69	89.07
Nominal RPM		680	680	680	680	680	680
Tip Speed	m/s	27.5	27.5	27.5	27.5	27.5	27.5
Motor kW	kW	0.75	0.75	0.75	0.75	0.75	0.75
Minimum Starting/Operating Ambient (2)							
Standard Unit	°C	0	0	0	0	0	0
Low-Ambient Unit	°C	-18	-18	-18	-18	-18	-18
General Unit							
Refrigerant		HFC 134a	HFC 134a	HFC 134a	HFC 134a	HFC 134a	HFC 134a
Number of Independent Refrigerant Circuits		2	2	2	2	2	2
% Minimum Load (3)		13	13	13	10	10	10
Operating Weight (4)	kg	8440	9818	10337	12097	12627	13325
Shipping Weight (4)	kg	7820	9623	10141	11924	12434	13109

Notes:

1. Data containing information on two circuits shown as follows: ckt1/ckt2
2. Minimum start-up/operation ambient based on a 2.22 m/s (5mph) wind across the condenser.
3. Percent minimum load is for total machine at 10°C (50°F) ambient and 7°C (44°F) leaving chilled water temperature, not each individual circuit.
4. With aluminium fins.
5. At Eurovent conditions, 7°C leaving water temperature and 35°C entering condenser air temperature.
6. Ratings based on sea level altitude and evaporator fouling factor of 0.017615 m²K/kW
7. Unit kW input, including fans

General Data

SI Units

Table G-12 - General Data RTAC 255-400 Extra Efficiency Low Noise

Size		255	275	300	355	375	400
Cooling capacity (5) (6)	kW	867.4	966.5	1090.3	1239.7	1334.3	1456.7
Power input (7)	kW	292.1	324.3	363.4	418.8	455.4	495.5
Energy Efficiency Ratio (5) (6) (as Eurovent)	kW/kW	2.97	2.98	3.00	2.96	2.93	2.94
ESEER (as Eurovent)	kW/kW	4.03	4.38	4.42	4.48	4.6	4.57
IPLV (According to ARI conditions 44°F leaving water temperature, 95°F entering air temperature)	kW/kW	4.50	4.57	4.44	4.7	4.98	4.95
Compressor							
Quantity		3	3	3	4	4	4
Nominal Size (1)	tons	70-70/100	85-85/100	100-100/100	70-70/100-100	100-100/85-85	100-100/100-100
Evaporator							
Evaporator Model		EH300	EH320	EH321	EH440	EH480	EH480
Water Storage	l	239	258	258	304	325	325
Minimum Flow	l/s	22	24	24	27	29	29
Maximum Flow	l/s	77	86	86	97	105	105
Number of water passes		2	2	2	2	2	2
Condenser							
Quantity of Coils		4/4	4/4	4/4	4/4	4/4	4/4
Coil Length	mm	4572/3658	5486/3658	6401/3658	6401/4572	6401/5486	6401/6401
Coil Height	mm	1067	1067	1067	1067	1067	1067
Fin series	fins/ft	180	180	180	180	180	180
Number of Rows		4	4	4	4	4	4
Condenser Fans							
Quantity (1)		10/6	12/8	14/8	14/10	14/12	14/14
Diameter	mm	762	762	762	762	762	762
Total Air Flow	m ³ /s	51.54	61.05	67.17	73.31	79.41	85.53
Nominal RPM		680	680	680	680	680	680
Tip Speed	m/s	27.5	27.5	27.5	27.5	27.5	27.5
Motor kW	kW	0.75	0.75	0.75	0.75	0.75	0.75
Minimum Starting/Operating Ambient (2)							
Standard Unit	°C	0	0	0	0	0	0
Low-Ambient Unit	°C	-18	-18	-18	-18	-18	-18
General Unit							
Refrigerant		HFC 134a	HFC 134a	HFC 134a	HFC 134a	HFC 134a	HFC 134a
Number of Independent Refrigerant Circuits		2	2	2	2	2	2
% Minimum Load (3)		13	13	13	10	10	10
Operating Weight (4)	kg	9540	10291	10964	11704	13233	14083
Shipping Weight (4)	kg	9436	10168	10843	11713	13196	14029

Notes:

1. Data containing information on two circuits shown as follows: ckt1/ckt2
2. Minimum start-up/operation ambient based on a 2.22 m/s (5mph) wind across the condenser.
3. Percent minimum load is for total machine at 10°C (50°F) ambient and 7°C (44°F) leaving chilled water temperature, not each individual circuit.
4. With aluminium fins.
5. At Eurovent conditions, 7°C leaving water temperature and 35°C entering condenser air temperature.
6. Ratings based on sea level altitude and evaporator fouling factor of 0.017615 m²K/kW
7. Unit kW input, including fans

Installation - Mechanical

Installation Responsibilities

Generally, the contractor must do the following when installing an RTAC unit:

- Install the unit on a flat foundation, level (within 1/4" [6 mm] across the length and width of the unit), and strong enough to support unit loading.
- Install the unit per the instructions contained in the Installation-Mechanical and Installation-Electrical sections of this manual.
- Make electrical connections at the CH.530.
- Where specified, provide and install valves in the water piping upstream and downstream of the evaporator water connections, to isolate the evaporator for maintenance and to balance and trim the system.
- Furnish and install a flow proving device and/or auxiliary contacts to prove chilled-water flow.
- Furnish and install pressure gauges in the inlet and outlet piping of the evaporator.
- Furnish and install a drain valve to the bottom of the evaporator water box.
- Supply and install a vent cock to the top of the evaporator water box.
- Furnish and install strainers ahead of all pumps and automatic modulating valves.
- Provide and install field wiring.
- Install heat tape and insulate the chilled-water lines and any other portions of the system, as required, to prevent sweating under normal operating conditions or freezing during low-ambient temperature conditions.
- Start the unit under the supervision of a qualified service technician.

Storage

Extended storage of the unit prior to installation requires the following precautionary measures:

1. Store the unit in a secure area.
2. At least every three months (quarterly), check the pressure in the refrigerant circuits to verify that the refrigerant charge is intact. If it is not, contact the appropriate sales office.
3. Close the optional discharge and liquid-line isolation valves.

Installation - Mechanical

Special Lifting and Moving Instructions

A specific lifting method is recommended as follows:

1. Lifting points are built into the unit. (There are four lifting points for RTAC 120-200, and eight lifting points for RTAC 230-400.)
2. Slings and spreader bar to be provided by rigger and attached to the lifting points.
3. Minimum rated lifting capacity (vertical) of each sling and spreader bar shall be no less than the tabulated unit shipping weight.

⚠ CAUTION

4. This unit must be lifted with the utmost care. Avoid shock load by lifting slowly and evenly.

Figure 3 – Rigging the Unit, Sizes 120-200

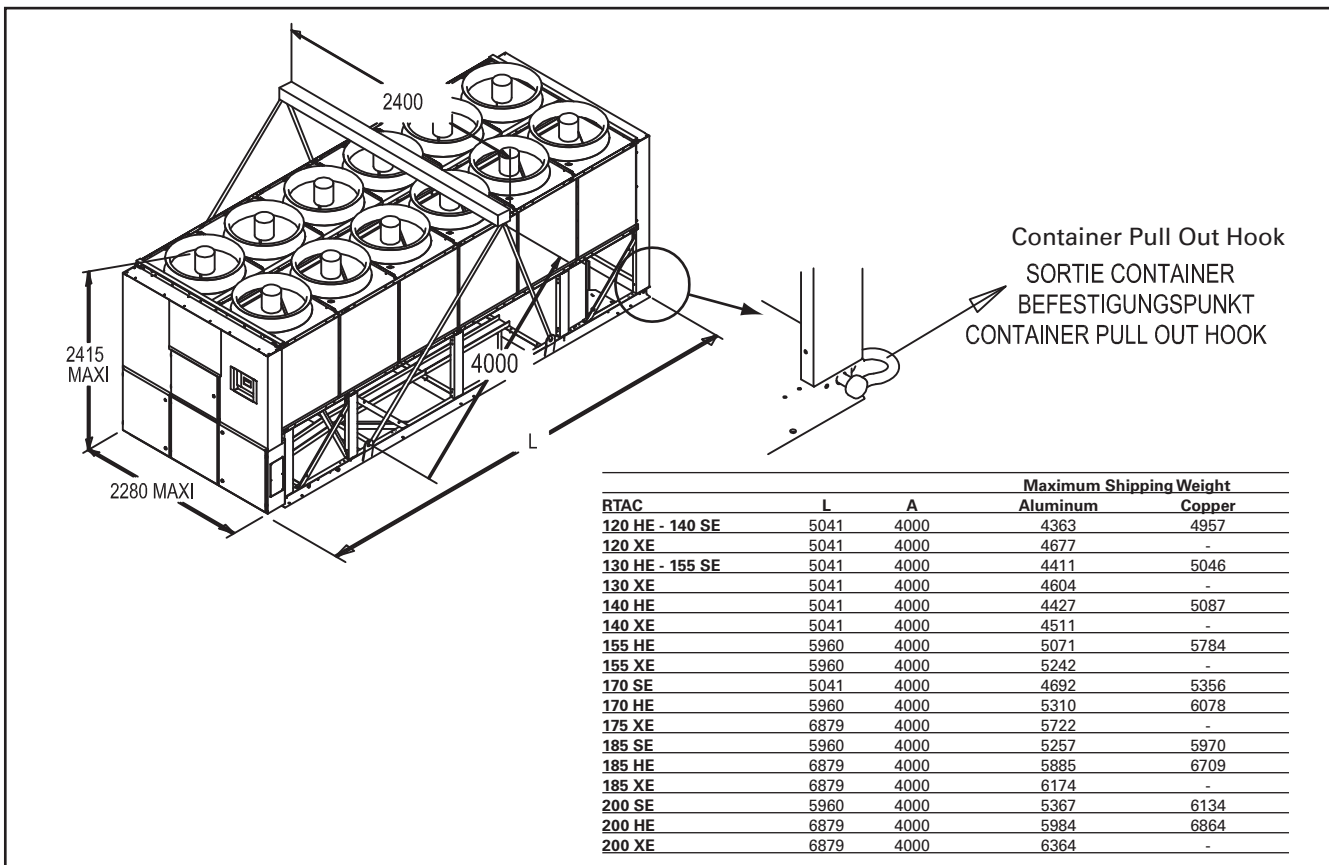

Installation - Mechanical

Figure 4 – Rigging the Unit, Sizes 230-400

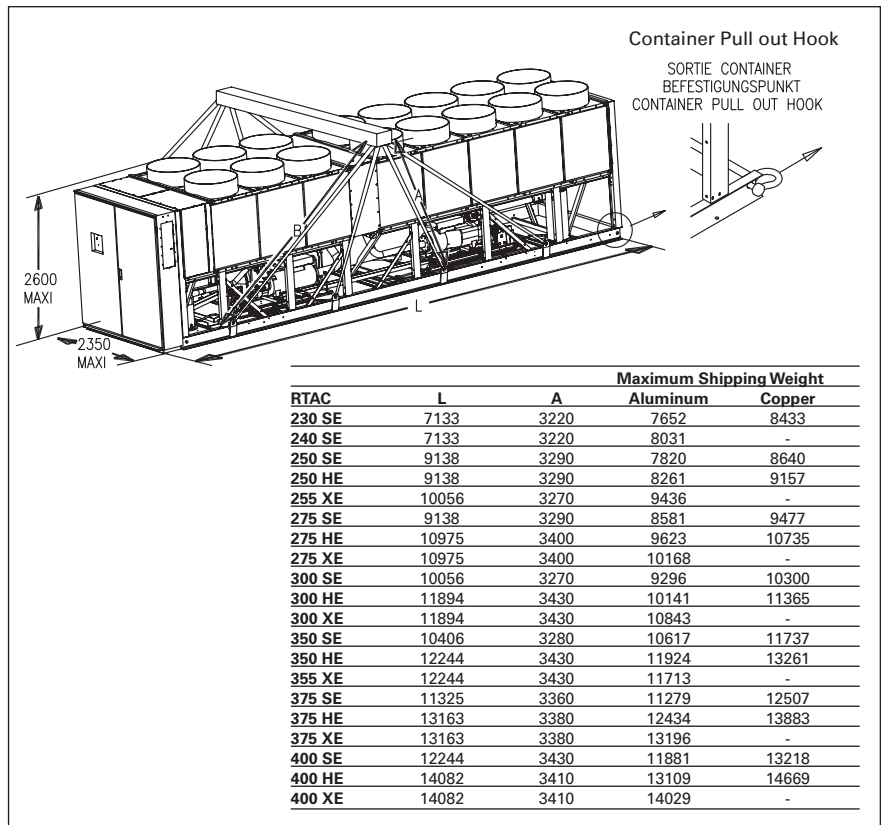

⚠ CAUTION

Refer to nameplate for unit weight and additional installation instructions contained inside the control panel. Other lifting arrangements may cause equipment damage or serious personal injury.

Isolation and Sound Emission

The most effective form of isolation is to locate the unit away from any sound-sensitive area. Structurally-transmitted sound can be reduced by elastomeric vibration eliminators. Spring isolators are not recommended. Consult an acoustical engineer in critical sound applications.

For maximum isolation effect, isolate water lines and electrical conduit. Wall sleeves and rubber-isolated piping hangers can be used to reduce the sound transmitted through water piping. To reduce the sound transmitted through electrical conduit, use flexible electrical conduit.

National and local codes on sound emissions should always be considered. Because the environment in which a sound source is located affects sound pressure, unit placement must be carefully evaluated. Sound-power levels are available on request.

Installation - Mechanical

Foundation

Provide rigid, non-warping mounting pads or a concrete foundation of sufficient strength and mass to support the unit operating weight (that is, including completed piping, and full operating charges of refrigerant, oil, and water). Refer to General Data Section for operating weights. After it is in place, the unit must be level within 1/4" [6 mm] over its length and width.

Trane is not responsible for equipment problems resulting from an improperly designed or constructed foundation.

Clearances

Provide enough space around the unit to allow the installation and maintenance personnel unrestricted access to all service points.

Unobstructed flow of condenser air is essential to maintain chiller capacity and operating efficiency. When determining unit placement, give careful consideration to ensuring a sufficient flow of air across the condenser heat-transfer surface.

In case of enclosure around the unit, the height of the enclosure **must not be higher than the unit**. If the enclosure is higher than the unit, restrictive airflow louvers should be fitted to ensure fresh air supply.

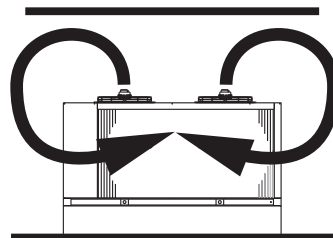

Dimensional Data

RTAC 120 - 200

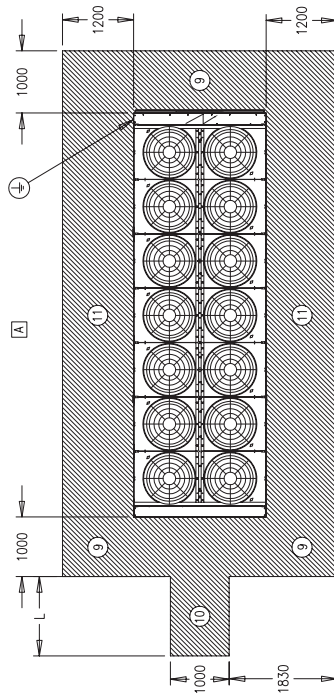

- Nombre de ventilateurs (J) voir plan implantation des composants
- Anzahl Luefter (J) : siehe montageskizze der Komponenten
- Number of fans (J), refer to the component location drawing
- Numero di ventilatori (J), fare riferimento al documento Disposizione dei componenti
- Aantal ventilatoren (J) : zie plaats van componenten
- Numero de ventiladores (J), ver dibujo de la localización de los componentes

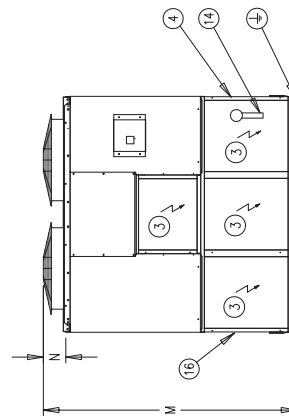
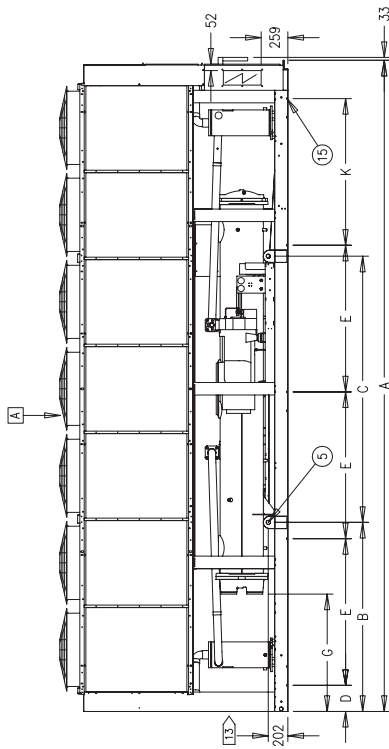
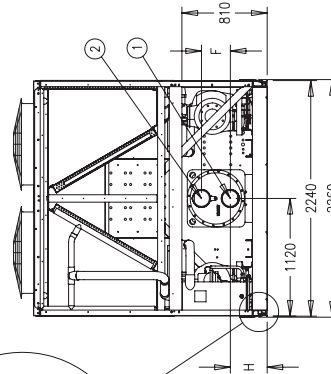
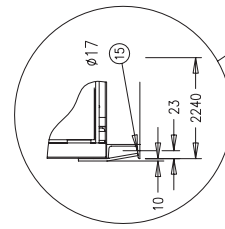

DIGIT 19	M	N
P (100 Pa Fans)	2381	182
X-L-Q (Other Fans)	2411	212

RTAC	A	B	C	D	E	F	G	H	J	K	L
120XE	5041	1439	2100	271	1456	252	524	291	8	-	1900
120HE-140SE	5041	1439	2100	271	1456	252	524	291	8	-	1900
130HE-155SE	5041	1439	2100	271	1456	252	524	291	9	-	1900
130XE	5041	1439	2100	271	1456	252	524	291	10	-	1900
140HE-140XE-170SE	5041	1439	2100	271	1456	274	505	350	10	-	1900
155HE-185SE	5960	1543	2812	273	1761	274	963	350	11	-	1500
175XE-185HE	6879	1997	2812	275	1550	274	1242	350	13	1550	1600
185XE-200HE-200XE	6879	1997	2812	275	1550	274	1242	350	14	1550	1600

Installation

REFROIDISSEURS DE LIQUIDE / WASSERKUEHLMASCHINEN / LIQUID CHILLERS

- | | | | |
|----|---|--|--|
| 1 | CONNEXION ENTREE D'EAU EVAPORATEUR | WASSER-EINTRITT-VERDAMPFER | EVAPORATOR WATER INLET CONNECTION |
| 2 | CONNEXION SORTIE D'EAU EVAPORATEUR | WASSER-AUSTRITT-VERDAMPFER | EVAPORATOR WATER OUTLET CONNECTION |
| 3 | ARMOIRE ELECTRIQUE | STEUERSCHRANK | ELECTRICAL PANEL |
| 4 | ACCES RACCORDEMENT CLIENT - ALIMENTATION PUISSANCE UNITE (155 x 400) | ABDECKPLATTE FÜR BAUSITZIGE KABELNÄHRUNG (155 x 400) | POWER CABLE GLAND PLATE FOR CUSTOMER WIRING (155 x 400) |
| 5 | POINT DE LEVAGE 045 | TRANSPORT-OESEN 045 | RINGING EYES 045 |
| 6 | MASSE EN FONCTIONNEMENT (Kg) | BETRIEGSGEWICHT (Kg) | OPERATING WEIGHT (Kg) |
| 7 | CHARGE DE FLUIDE FRIGORIGÈNE (Kg) R134a | KÄLTEMITTEL-FÜLLUNG (Kg) R134a | REFRIGERANT CHARGE (Kg) R134a |
| 8 | CHARGE D'HUILE (Litres) | ÖLFÜLLUNG (Liter) | OIL CHARGE (Litres) |
| 9 | AIRE CONSEILLÉE POUR MAINTENANCE | MINDEST-WANDABSTAND (ZUR WARTUNG) | MINIMUM CLEARANCE (FOR MAINTENANCE) |
| 10 | AIRE CONSEILLÉE POUR DETUBAGE DE L'EVAPORATEUR | MINDEST-WANDABSTAND (VERDAMPFER - AUSBÄU) | MINIMUM CLEARANCE (EVAPORATOR TUBES REMOVAL) |
| 11 | AIRS NECESSAIRE POUR ENTREE D'AIR | MINDEST WANDABSTAND (LUFTEINTRITT) | MINIMUM CLEARANCE (AIR ENTERING) |
| 12 | ACCES RACCORDEMENT-CONTROLE ET REGULATION (3 PRESSE-ETOUFES 2 PG13,5 + 1 PG9) | ABDECKPLATTE FÜR BAUSITZIGE STEUER VERKABELUNG (3 KABELVERSCHÜBLUNG 2 PG 13,5 + 1 PG9) | EXTERNAL CONTROL WIRING CABLE GLAND PLATE FOR CUSTOMER WIRING (3 CABLE GLAND 2 PG 13,5 + 1 PG 9) |
| 13 | PASSAGE PROPOSE POUR CONNEXIONS | EMPHOHLENE KALTWASSER ROHRLÜFTUNGSPÜHRUNG | RECOMMENDED CHILLED WATER PIPEWORK LAYOUT |
| 14 | SECTIONNEUR PUISSANCE | SCHALTSCHRANK HAUPTSCHALTER | POWER DISCONNECT SWITCH |
| 15 | AMORTISSEURS | DAEMPFER | ISOLATORS |

- | | | | |
|----|--|--|--|
| 1 | COLLEGAMENTO INGRESSO ACQUA | VERDAMPFER WATERINTREDE | CONEXION DE ENTRADA DE AGUA AL EVAPORADOR |
| 2 | COLLEGAMENTO USCITA ACQUA | VERDAMPFER WATERUITREDE | CONEXION DE SALIDA DE AGUA DEL EVAPORADOR |
| 3 | PANNELLO DI CONTROLLO | BESTURINGSPANEEL | PANEL DE CONTROL |
| 4 | ACCESO RACCORRI CLIENTE - ALIMENTAZIONE DI POTENZA (155 x 400) | BLINDPLAAT TEN BEHOEVE VAN VOEDINGSKABEL KLANT (155 x 400) | ACCESO PARA EL CABLEADO DE FUERZA A REALIZAR POR EL CUENTE (155 x 400) |
| 5 | GOLFARI 045 | HUISOGEN 045 | PUNTOS DE ELEVACION 045 |
| 6 | PESO IN FUNZIONAMENTO (Kg) | BETRIEGSGEWICHT (Kg) | PESO EN OPERACION (Kg) |
| 7 | CARICA DI FLUIDO FRIGORIGENO (Kg) R134a | KOUDEMIDDELVULLING (Kg) R134a | CARGA DE REFRIGERANTE (Kg) R134a |
| 8 | CARICA D'OILIO (Litri) | OLIEVULLING (Litres) | CARGA DE ACEITE (Litros) |
| 9 | MINIMO SPAZIO DI SERVIZIO | MINIMUM VRIJLE RUIMTE (VOOR ONDERHOUD) | ESPACIO LIBRE MINIMO PARA MANTENIMIENTO |
| 10 | SPAZI MINIMI RICHIESTI PER LA RIMOZIONE TUBI EVAPORATORE | MINIMUM AFBAND (VERVANGEN VERDAMPFER PIPEN) | ESPACIO LIBRE PARA EXTRA DE AIR |
| 11 | SPAZIO PER ARIA IN ENTRATA | MINIMALE VRIJLE RUIMTE VOOR LUCHTINTREDE | ESPACIO LIBRE MINIMO PARA TOMA DE AIR |
| 12 | ACCESO RACCORRI CLIENTE - CONTROLLO E REGOLAR (3 PREMISTOPPA 2 PG13,5 + 1 PG9) | BLINDPLAAT TEN BEHOEVE VAN EXTERNE STRUCTUURKABEL KLANT (3 WARTELS 2 PG13,5 + 1 PG9) | ACCESO RACCORRI CLIENTE-ALIMENTAZIONE CONTROLLO E REGOLAZIONE (3 PASSACAMI 2 PG13,5 + 1 PG9) |
| 13 | COLLEGAMENTO IDRAULICO RACCOMANDATO | AANBEVOLEN GEKOELEDWATER LEDINGSLOOP | DISTRIBUCION DE TUBERIAS DE AGUA FRIA RECOMENDATA |
| 14 | SEZIONATORE DI POTENZA | HOOFDSCHAKELAAR | SECCIONADOR DE FUERZA |
| 15 | ANTIURBANTI | DEMPERS | AMORTIGUADORES |

- | | | | |
|----|--|--|--|
| 1 | COLLEGAMENTO INGRESSO ACQUA | VERDAMPFER WATERINTREDE | CONEXION DE ENTRADA DE AGUA AL EVAPORADOR |
| 2 | COLLEGAMENTO USCITA ACQUA | VERDAMPFER WATERUITREDE | CONEXION DE SALIDA DE AGUA DEL EVAPORADOR |
| 3 | PANNELLO DI CONTROLLO | BESTURINGSPANEEL | PANEL DE CONTROL |
| 4 | ACCESO RACCORRI CLIENTE - ALIMENTAZIONE DI POTENZA (155 x 400) | BLINDPLAAT TEN BEHOEVE VAN VOEDINGSKABEL KLANT (155 x 400) | ACCESO PARA EL CABLEADO DE FUERZA A REALIZAR POR EL CUENTE (155 x 400) |
| 5 | GOLFARI 045 | HUISOGEN 045 | PUNTOS DE ELEVACION 045 |
| 6 | PESO IN FUNZIONAMENTO (Kg) | BETRIEGSGEWICHT (Kg) | PESO EN OPERACION (Kg) |
| 7 | CARICA DI FLUIDO FRIGORIGENO (Kg) R134a | KOUDEMIDDELVULLING (Kg) R134a | CARGA DE REFRIGERANTE (Kg) R134a |
| 8 | CARICA D'OILIO (Litri) | OLIEVULLING (Litres) | CARGA DE ACEITE (Litros) |
| 9 | MINIMO SPAZIO DI SERVIZIO | MINIMUM VRIJLE RUIMTE (VOOR ONDERHOUD) | ESPACIO LIBRE MINIMO PARA MANTENIMIENTO |
| 10 | SPAZI MINIMI RICHIESTI PER LA RIMOZIONE TUBI EVAPORATORE | MINIMUM AFBAND (VERVANGEN VERDAMPFER PIPEN) | ESPACIO LIBRE PARA EXTRA DE AIR |
| 11 | SPAZIO PER ARIA IN ENTRATA | MINIMALE VRIJLE RUIMTE VOOR LUCHTINTREDE | ESPACIO LIBRE MINIMO PARA TOMA DE AIR |
| 12 | ACCESO RACCORRI CLIENTE - CONTROLLO E REGOLAR (3 PREMISTOPPA 2 PG13,5 + 1 PG9) | BLINDPLAAT TEN BEHOEVE VAN EXTERNE STRUCTUURKABEL KLANT (3 WARTELS 2 PG13,5 + 1 PG9) | ACCESO RACCORRI CLIENTE-ALIMENTAZIONE CONTROLLO E REGOLAZIONE (3 PASSACAMI 2 PG13,5 + 1 PG9) |
| 13 | COLLEGAMENTO IDRAULICO RACCOMANDATO | AANBEVOLEN GEKOELEDWATER LEDINGSLOOP | DISTRIBUCION DE TUBERIAS DE AGUA FRIA RECOMENDATA |
| 14 | SEZIONATORE DI POTENZA | HOOFDSCHAKELAAR | SECCIONADOR DE FUERZA |
| 15 | ANTIURBANTI | DEMPERS | AMORTIGUADORES |

RTAC 120 - 200 50Hz



RTAC	Digit 18	(6) (Kg)	(7) (Kg)	(8) (L.)	(1) (1)	(2)
120HE	AL "X" x 50"	4461	75 + 75			
	CU, "2"	5065				
120XE	AL "X" x 50"	4775	77 + 77			
	CU, "2"	4510				
130HE	AL "X" x 50"	5154	79 + 75			4"
	CU, "2"	4712				
130XE	AL "X" x 50"	4481	92 + 77			
	CU, "2"	5065				
140HE	AL "X" x 50"	4529	79 + 79	6 + 6		
	CU, "2"	5189				
140XE	AL "X" x 50"	4813	92 + 92			6"
	CU, "2"	4659				
155SE	AL "X" x 50"	5080	79 + 75			
	CU, "2"	5180				
155HE	AL "X" x 50"	5283	98 + 93			
	CU, "2"	5351				
155XE	AL "X" x 50"	4794	114 + 96			4"
	CU, "2"	5589				
170HE	AL "X" x 50"	5431	98 + 98			
	CU, "2"	6199				
175XE	AL "X" x 50"	5842	119 + 96	8,5 + 6		
	CU, "2"	5666				
185SE	AL "X" x 50"	6079	98 + 95			
	CU, "2"	6793				
185HE	AL "X" x 50"	6005	102 + 98	8,5 + 8		6"
	CU, "2"	6829				
185XE	AL "X" x 50"	6571	119 + 99			
	CU, "2"	6971				
200SE	AL "X" x 50"	5488	98 + 98			
	CU, "2"	6255				
200HE	AL "X" x 50"	6117	102 + 102	8,5 + 8,5		
	CU, "2"	6997				
200XE	AL "X" x 50"	6497	119 + 119			
	CU, "2"	6497				

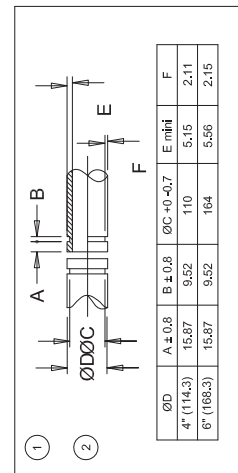

Installation



RTAC 230-400

REFROIDISSEURS DE LIQUIDE / WASSERKUEHLMASCHINEN / LIQUID CHILLERS

- | | | |
|----|---|---|
| 1 | CONNEXION ENTRE DEAU EVAPORATEUR
WASSER-EINTRITT-VERDAMPFER | EVAPORATOR WATER INLET CONNECTION |
| 2 | CONNEXION SORTIE DEAU EVAPORATEUR
WASSER-AUSTRITT-VERDAMPFER | EVAPORATOR WATER OUTLET CONNECTION |
| 3 | ARMOIRE ELECTRIQUE
STEUERSCHRANK | ELECTRICAL PANEL |
| 4 | ACCES RACCORDEMENT CLIENT -
ALIMENTATION PUISSANCE UNITE
ABDECKPLATTE FÜR BAUSÄTZIGE
KABELN FÜHRUNG | POWER CABLE GLAND PLATE
FOR CUSTOMER WIRING |
| 5 | POINT DE LEVAGE 045
TRANSPORT-GESEN 045 | LIFTING EYES 045 |
| 6 | MASSE EN FONCTIONNEMENT (Kg)
BETRIEBSGEWICHT (Kg) | OPERATING WEIGHT (Kg) |
| 7 | CHARGE DE FLUIDE FRIGORISANT (Kg) R134a
KÄLTEMITTEL-FÜLLUNG (Kg) R134a | REFRIGERANT CHARGE (Kg) R134a |
| 8 | CHARGE D'HUILE (Litres)
ÖLFÜLLUNG (Litres) | OIL CHARGE (Litres) |
| 9 | AIR CONSEILLÉ POUR MAINTENANCE
MINDEST-WANDABSTAND (ZUR WARTUNG) | MINIMUM CLEARANCE (FOR MAINTENANCE) |
| 10 | AIR CONSEILLÉ POUR DÉTUBAGE DE
L'EVAPORATEUR
MINDEST-WANDABSTAND (VERDAMPFER -
ABSAUG) | MINIMUM CLEARANCE (EVAPORATOR TUBES
REMOVAL) |
| 11 | AIR NÉCESSAIRE POUR ENTRÉE D'AIR
MINDEST WANDABSTAND (LUFTENTRITT) | MINIMUM CLEARANCE (AIR ENTERING) |
| 12 | POTEAU
SENKRECHTE STREBEN | FRAME POST |
| 13 | ACCÈS RACCORDEMENT-CONTROL
ET REGULATION (3 PRESSE-ETOUPEES
PG 13.5)
ZUGANG FÜR KABELN UND WASSER
LEITUNGSFÜHRUNG | EXTERNAL CONTROL WIRING CABLE GLAND
PLATE FOR CUSTOMER WIRING (3 CABLE GLAND
PG 13.5)
RECOMMENDED CHILLED WATER PIPEWORK
LAYOUT |
| 14 | SECTIONNEUR PUISSANCE
AMORTISSEURS | POWER DISCONNECT SWITCH
ISOLATORS |
| 15 | SCHALTSCHRANK-HAUPTSCHALTER
DAEMPFER | DEMPERS |

OPTIONS / ZUBEHÖR / OPTIONS

RTAC	Digit.12	Digit.18	(6) (Kg.)	(7) (Kg.)	(8) (L.)	(1) (2)
230	Standard "N"	AL "X-3-5"	7875	128 + 102	16 + 9	6"
		CU, "2"	8656	128 + 102	16 + 9	
240	Standard "N"	AL "X-3-5"	8255	136 + 130	16 + 9	

REFRIGERATO DI LIQUIDO / WATKOELEMACHINE / ENFRIADORA DE LIQUIDO

- | | | |
|----|--|---|
| 1 | COLLEGAMENTO INGRESSO ACQUA
VERDAMPFER WATERTITREDE | CONEXION DE ENTRADA DE AGUA AL
EVAPORADOR |
| 2 | COLLEGAMENTO USCITA ACQUA EVAPORATORE
VERDAMPFER WATERTITREDE | CONEXION DE SALIDA DE AGUA DEL
EVAPORADOR |
| 3 | PANNELLO DI CONTROLLO
BESTURINGSPANEEL | PANEL DE CONTROL |
| 4 | ACCESO RACCORDI CLIENTE -
ALIMENTAZIONE DI POTENZA
AUMENTAZIONE CLIENTE | ACCESO PARA EL CABLEADO DE FUERZA
A REALIZAR POR EL CLIENTE |
| 5 | GOLFARI 045
HUISOGEN 045 | PUNTOS DE ELEVACION 045 |
| 6 | PESO IN FUNZIONAMENTO (Kg)
BETRIEBSGEWICHT (Kg) | PESO EN OPERACION (Kg) |
| 7 | CARICA DI FLUIDO FRIGORIGENO (Kg) R134a
KOUDEMIDDELVULLING (Kg) R134a | CARGA DE REFRIGERANTE (Kg) R134a |
| 8 | CARICA D'OLIO (Litres)
OLEVULLING (Litres) | CARGA DE ACEITE (Litres) |
| 9 | MINIMO SPAZIO DI SERVIZIO
MINIMUM VRIJE RUIMTE (VOOR ONDERHOUD) | ESPACIO LIBRE MINIMO PARA MANTENIMIENTO |
| 10 | SPAZI MINIMI RICHIESTI PER LA RIMOZIONE
TUBI EVAPORATORE
MINIMUM AFSTAND (VERVANGENVERDAMPFER
PIJPEN) | ESPACIO LIBRE PARA EXTRA
MINIMALE VRIJE RUIMTE VOOR LUCHTITREDE |
| 11 | SPAZIO PER ARIA IN ENTRATA
STANDER | ESPACIO LIBRE MINIMO PARA TOMA DE AIRE |
| 12 | TELAIO DI SOSTEGNO
BLINDPLAAT TEN BEHOEVE VAN
VOEDINGSKABEL KLANT | COLUMNA DE SOPORTE |
| 13 | ACCESO RACCORDI CLIENTE CONTROLLO
E REGOLAZIONE (3 PREMISTOPPA PG 13.5)
KUNST (3 WARTSELS PG 13.5) | ACCESO RACCORDI CLIENTE ALIMENTAZIONE
E REGOLAZIONE (3 PASSACAVI
PG 13.5) |
| 14 | COLLEGAMENTO IDRAULICO RACCOMANDATO
AANBEVOLEN GEKOELEWATERLEIDINGLOOP
RECOMMENDATA | DISTRIBUCION DE TUBERIAS DE AGUA FRIA
RECOMENDADA |
| 15 | SECTIONNATORE DI POTENZA
AMORTISSEURS | SECTIONNADOR DE FUERZA
AMORTISADORES |

OPZIONI / TOEBEHOREN / OPCIONES

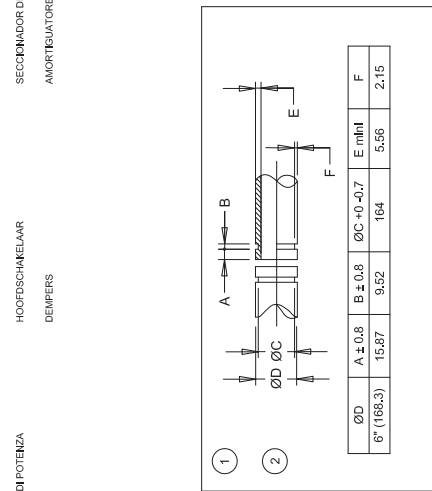

Installation

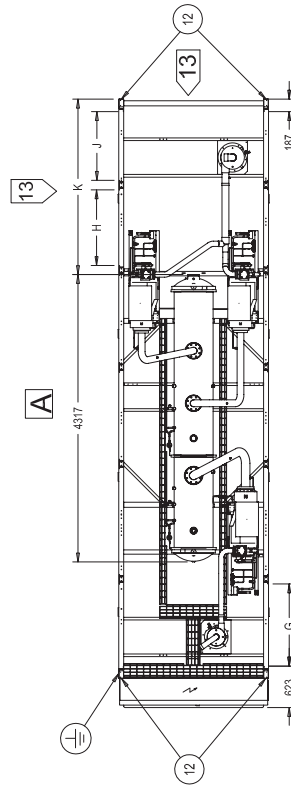
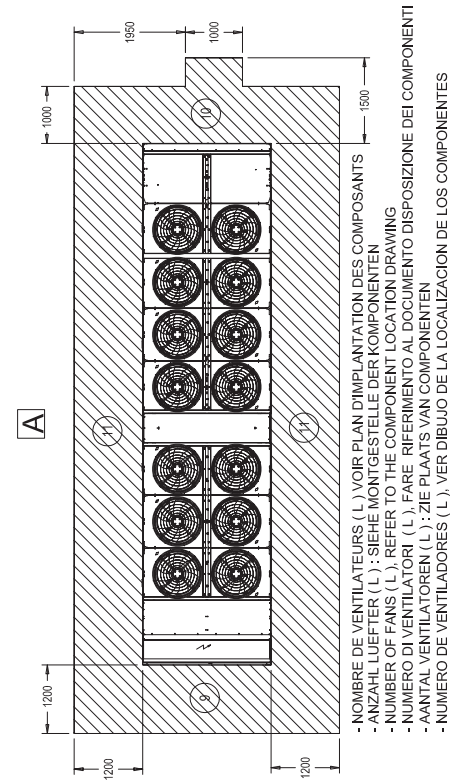

RTAC	A	B	C	D	E	F	G	H	J	K	L	M
250 SE	9138	2030	2150	2030	1500	1620	1234	1135	1032	2634	14	5
250 HE	9138	2030	2150	2030	1500	1620	1234	1272	992	2634	16	5
255 XE	10056	2032	2032	2032	1732	1503	1578	1272	992	3112	16	6
275 SE	9138	2030	2030	2030	1500	1620	1234	1272	992	2629	16	5
275 HE	10975	1905	2794	1905	1923	1656	1578	1662	1258	3108	18	6
275 XE	10975	1905	2794	1905	1923	1656	1578	1662	1258	3108	20	6
300 SE	10056	2032	2032	2032	1732	1503	1234	1625	1258	2951	18	6
300 HE	11894	2161	2921	2161	2208	1811	1578	1858	1769	3650	20	6
300 XE	11894	2161	2921	2161	2208	1811	1578	1858	1769	3650	22	6

RTAC 250-275-300 50hz

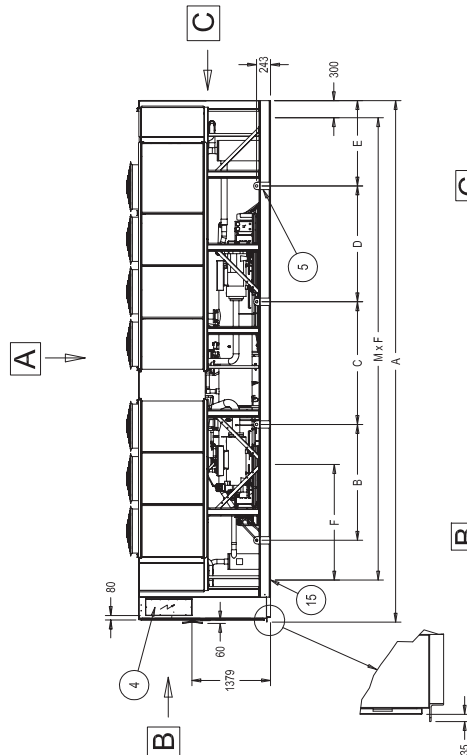

DIGIT	19	M	N
P		2500	182
(100 PA FANS)			
X-L-Q		2530	212
(OTHER FANS)			

Dimensional Data

RTAC 350-375-400 50Hz

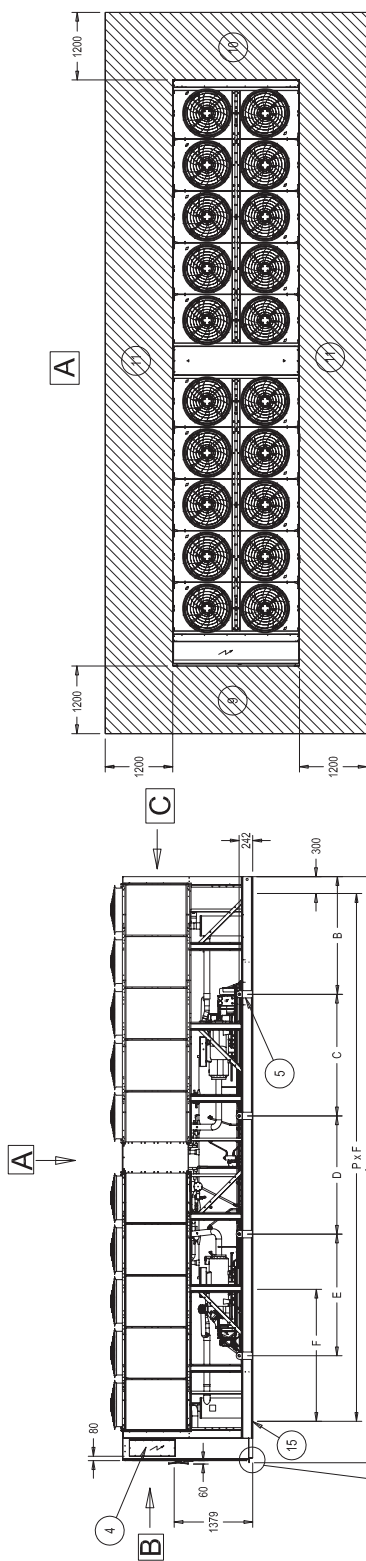

- NOMBRE DE VENTILATEURS (N) VOIR PLAN D'IMPLANTATION DES COMPOSANTS
 - ANZAHL LUEFTER (N) : SIEHE MONTGESTELLE DER KOMPONENTEN
 - NUMBER OF FANS (N), REFER TO THE COMPONENT LOCATION DRAWING
 - NUMERO DI VENTILATORI (N), FARE RIFERIMENTO AL DOCUMENTO DISPOSIZIONE DEI COMPONENTI
 - AANTAL VENTILATOREN (N) : ZIE PLAATS VAN COMPONENTEN
 - NUMERO DE VENTILADORES (N), VER DIBUJO DE LA LOCALIZACION DE LOS COMPONENTES

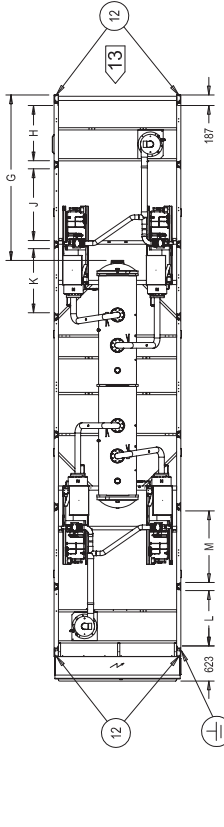

RTAC	A	B	C	D	E	F	G	H	J	K	L	M	N	P
350 SE	10406	2089	2159	2100	2159	1339	2933	992	1272	1140	992	1272	20	7
350 HE	12244	2435	2330	2900	2330	1402	3852	1258	1652	1652	1258	1652	24	8
355 XE	12244	2435	2330	2900	2330	1402	3852	1814	1812	1862	992	1272	24	8
375 SE	11325	2520	2159	2591	2159	1285	3852	1258	1652	1652	992	1272	22	8
375 HE	13163	3034	2513	2667	2513	1516	4771	1814	1812	1862	1258	1652	26	8
375 XE	13163	3034	2513	2667	2513	1516	4771	1814	1812	1862	1258	1652	24	8
400 SE	12244	2435	2330	2900	2330	1402	3852	1258	1652	1652	1258	1652	26	8
400 HE	14082	3212	2620	2600	2620	1631	4771	1814	1812	1862	1814	1812	28	8
400 XE	14082	3212	2620	2600	2620	1631	4771	1814	1812	1862	1814	1812	28	8

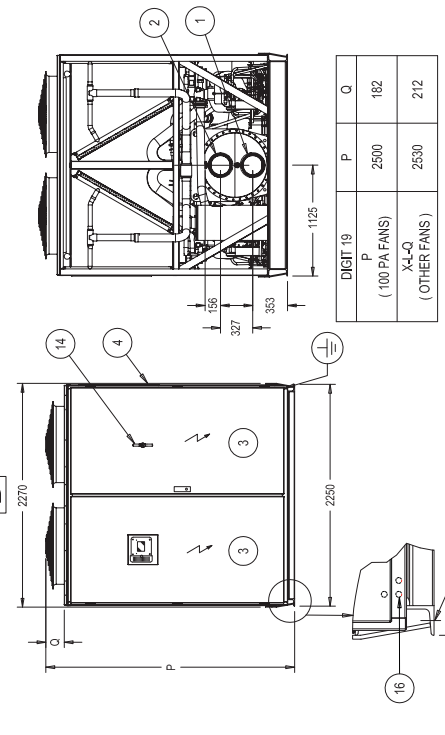

DIGIT 19	P	Q
(100 PA FANS)	2500	182
X+L-Q (OTHER FANS)	2530	212



RTAC 250-400

REFROIDISSEURS DE LIQUIDE / WASSERKUEHLMASCHINEN / LIQUID CHILLERS

- 1 CONNEXION ENTREEE D'EAU EVAPORATEUR WASSER-EINTRITT/VERDAMPFER
- 2 CONNEXION SORTIE D'EAU EVAPORATEUR WASSER-AUSTRITT/VERDAMPFER
- 3 AMRIGNE ELECTRIQUE STEUERSTRANK
- 4 PAINTELLO DI CONTROLLO BESTURUNGSPANEEL
- 5 ALIMENTAZIONE CLIENTE ALIMENTAZIONE KLIJNT VOEDINGSKABEL
- 6 ALIMENTAZIONE UNITA ALIMENTAZIONE EENHEID VOEDINGSKABEL
- 7 PUNTO DI LEVAGGIO 045 TRANSPORT-OESER 045
- 8 CARICA DI FLUIDO FRIGORIFERO (Kg) R134a OELVULLING (litres)
- 9 CARIC D'HUILE (litres)
- 10 AIRE CONSEILLEE POUR MAINTENANCE MINDEST-WANDABSTAND (ZUR WARTUNG)
- 11 AIRE CONSEILLEE POUR DETUBAGE DE L'EVAPORATEUR MINDEST-WANDABSTAND (VERDAMPFER - AUSBAU)
- 12 AIRE NECESSAIRE POUR ENTREE D'AIR MINDEST WINDABSTAND (LUFT-EINTRITT)
- 13 ACCESSO RACCORDI CLIENTE A REALIZAR PER EL CLIENTE ABEKPLATTE FÜR BAUSITZIGE KLIJNT VOEDINGSKABEL
- 14 ACCESSO RACCORDI CLIENTE A REALIZAR PER EL CLIENTE EMPFOHLENE KALTWASSER KABELVERSCHEIBUNG (PG.13.5)
- 15 ACCESSO RACCORDI CLIENTE A REALIZAR PER EL CLIENTE EMPFOHLENE KALTWASSER ROHRLEITUNGSFÜHRUNG (PG.13.5)

OPTIONS / ZUBEHOER / OPTIONS

- 14 SECCIONNEUR PUISSANCE SCHALTSTRANK HAUPTSCHALTER
- 15 AMORTISSEURS DAMPFER
- 1 COLLEGAMENTO INGRESSO ACQUA VERDAMPFER WATERINREDE
- 2 COLLEGAMENTO USCITA ACQUA EVAPORATORE VERDAMPFER WATERUITREDE
- 3 PANNELLO DI CONTROLLO BESTURUNGSPANEEL
- 4 ACCESSO RACCORDI CLIENTE - A REALIZAR PER EL CLIENTE VOEDINGSKABEL KLIJNT
- 5 ALIMENTAZIONE CLIENTE ALIMENTAZIONE KLIJNT VOEDINGSKABEL
- 6 ALIMENTAZIONE UNITA ALIMENTAZIONE EENHEID VOEDINGSKABEL
- 7 PUNTO DI LEVAGGIO 045 TRANSPORT-OESER 045
- 8 CARICA DI FLUIDO FRIGORIFERO (Kg) R134a KOUDEMEDELVULLING (Kg) R134a
- 9 CARIC D'HUILE (litres) OLEVULLING (litres)
- 10 MINIMO SPAZIO DI SERVIZIO MINIMUM VRIJLE RUIMTE (VOOR ONDERHOUD)
- 11 SPAZIO MINIMI RICHIESTI PER LA RIMOZIONE DELL'EVAPORATORE MINIMUMAFSTAND (VERVANGINGSVERDAMPFER) FÜR BAUSITZIGE KLIJNT VOEDINGSKABEL
- 12 SPAZIO PER ARIA D'ENTRATA MINIMUM VRIJLE RUIMTE VOOR LUCHTINREDE
- 13 ACCESSO RACCORDI CLIENTE A REALIZAR PER EL CLIENTE ABEKPLATTE FÜR BAUSITZIGE KLIJNT VOEDINGSKABEL
- 14 ACCESSO RACCORDI CLIENTE A REALIZAR PER EL CLIENTE EMPFOHLENE KALTWASSER KABELVERSCHEIBUNG (PG.13.5)
- 15 ACCESSO RACCORDI CLIENTE A REALIZAR PER EL CLIENTE EMPFOHLENE KALTWASSER ROHRLEITUNGSFÜHRUNG (PG.13.5)

OPZIONI / TOEBEHOREN / OPCIONES

- 14 SEZIONATORE DI POTENZA HOOFDSCHAKELAAR
- 15 ANTIVIBRANTI DAMPFERS
- 1 CONEXION DE ENTRADA DE AGUA AL EVAPORADOR WASSER-EINTRITT/VERDAMPFER
- 2 CONEXION DE SALIDA DE AGUA DEL EVAPORADOR WASSER-AUSTRITT/VERDAMPFER
- 3 PANEL DE CONTROL BESTURUNGSPANEEL
- 4 ACCESO PARA EL CABLEADO DE FUERZA A REALIZAR POR EL CLIENTE VOEDINGSKABEL KLIJNT
- 5 PUNTO DE ELEVACION 045 TRANSPORT-OESER 045
- 6 PESO EN OPERACION (Kg) CARGA DE REFRIGERANTE (Kg) R134a
- 7 PESO EN OPERACION (Kg) CARGA DE ACEITE (litres)
- 8 ESPACIO LIBRE MINIMO PARA MANTENIMIENTO MINIMUM VRIJLE RUIMTE (VOOR ONDERHOUD)
- 9 ESPACIO LIBRE MINIMO PARA EXTRA MANTENIMIENTO MINIMUMAFSTAND (VERVANGINGSVERDAMPFER) FÜR BAUSITZIGE KLIJNT VOEDINGSKABEL
- 10 ESPACIO LIBRE MINIMO PARA TOMA DE AIRE MINIMUM VRIJLE RUIMTE VOOR LUCHTINREDE
- 11 ESPACIO PARA SOPORTE DE LA COLUMNA DE SOPORTE ABEKPLATTE FÜR BAUSITZIGE KLIJNT VOEDINGSKABEL
- 12 ESPACIO PARA SOPORTE DE LA COLUMNA DE SOPORTE ABEKPLATTE FÜR BAUSITZIGE KLIJNT VOEDINGSKABEL
- 13 ACCESO PARA SOPORTE DE LA COLUMNA DE SOPORTE ABEKPLATTE FÜR BAUSITZIGE KLIJNT VOEDINGSKABEL
- 14 ACCESO PARA SOPORTE DE LA COLUMNA DE SOPORTE ABEKPLATTE FÜR BAUSITZIGE KLIJNT VOEDINGSKABEL
- 15 ACCESO PARA SOPORTE DE LA COLUMNA DE SOPORTE ABEKPLATTE FÜR BAUSITZIGE KLIJNT VOEDINGSKABEL

Dimensional Data

RTAC	Digit 18	(6) (kg.)	(7) (kg.)	(8) (L.)	(1) (2)
250SE	AL "X-3-5" Cu. "2"	7958	152 + 91		
250HE	AL "X-3-5" Cu. "2"	8779	186 + 91	18 + 9.5	
255XE	AL "X-3-5" Cu. "2"	9338	184 + 126		
275SE	AL "X-3-5" Cu. "2"	8745	166 + 91		6"
275HE	AL "X-3-5" Cu. "2"	9818	188 + 91	18 + 9.5	
275XE	AL "X-3-5" Cu. "2"	10931	205 + 126		
300SE	AL "X-3-5" Cu. "2"	8473	188 + 91		
300HE	AL "X-3-5" Cu. "2"	10337	209 + 91	21 + 9.5	
300XE	AL "X-3-5" Cu. "2"	11562	230 + 126		
350SE	AL "X-3-5" Cu. "2"	10779	166 + 166	18 + 18	
350HE	AL "X-3-5" Cu. "2"	12097	188 + 188	18 + 18	
355XE	AL "X-3-5" Cu. "2"	12217	230 + 184	21 + 18	
375SE	AL "X-3-5" Cu. "2"	11438	188 + 166	21 + 18	
375HE	AL "X-3-5" Cu. "2"	12668	209 + 188	21 + 20	8"
375XE	AL "X-3-5" Cu. "2"	14077	230 + 205		
400SE	AL "X-3-5" Cu. "2"	12051	188 + 188	21 + 21	
400HE	AL "X-3-5" Cu. "2"	13325	209 + 209	21 + 21	
400XE	AL "X-3-5" Cu. "2"	14885	230 + 230	21 + 21	

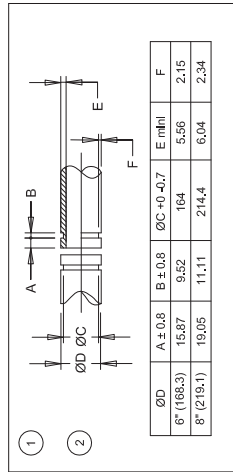

Installation - Mechanical

Unit Isolation and Levelling

For additional reduction of sound and vibration, install the optional neoprene isolators.

Construct an isolated concrete pad for the unit or provide concrete footings at the unit mounting points. Mount the unit directly to the concrete pads or footings.

Level the unit using the base rail as a reference. The unit must be level within 1/4" [6 mm] over the entire length and width. Use shims as necessary to level the unit.

Neoprene Isolator Installation

Secure the isolators to the mounting surface using the mounting slots in the isolator base plate. **DO NOT** fully tighten the isolator mounting bolts at this time.

See unit submittals for isolator placement, maximum weights, and isolator diagrams.

Align the mounting holes in the base of the unit with the threaded positioning pins on the top of the isolators.

Lower the unit onto the isolators and secure the isolator to the unit with a nut. The maximum isolator deflection should be 1/4" [6 mm].

Level the unit carefully. Fully tighten the isolator mounting bolts.

Drainage

Provide a large-capacity drain for water vessel drain-down during shutdown or repair. The evaporator is provided with a drain connection. All local and national codes apply. The vent on the top of the evaporator water box is provided to prevent a vacuum, by allowing air into the evaporator for complete drainage.

Evaporator grooved pipe

Thoroughly flush all water piping to the unit before making the final piping connections to the unit.

⚠ CAUTION

If using an acidic commercial flushing solution, construct a temporary bypass around the unit to prevent damage to internal components of the evaporator.

To avoid possible equipment damage, do not use untreated or improperly treated system water.

⚠ CAUTION

Trane assumes no responsibility for equipment failures which results from untreated or improperly treated water or saline or brackish water.

⚠ CAUTION

The chilled-water connections to the evaporator are to be "grooved pipe" type connections. Do not attempt to weld these connections, because the heat generated from welding can cause microscopic and macroscopic fractures on the cast-iron water boxes that can lead to premature failure of the water box. An optional grooved pipe stub and coupling is available for welding on flanges.

To prevent damage to chilled-water components, do not allow evaporator pressure (maximum working pressure) to exceed 150 psig [10.5 bar].

Provide shutoff valves in lines to the gauges, in order to isolate them from the system when they are not in use. Use rubber vibration eliminators to prevent vibration transmission through the water lines. If desired, install thermometers in the lines to monitor entering- and leaving-water temperatures. Install a balancing valve in the leaving-water line to control water flow balance. Install shutoff valves on both the entering- and leaving-water lines so that the evaporator can be isolated for service.

⚠ CAUTION

A pipe strainer must be installed in the entering water line. Failure to do so can allow waterborne debris to enter the evaporator.

"Piping components" include all devices and controls used to provide proper water system operation and unit operating safety. These components and their general locations are given on the next page.

Installation - Mechanical

Water Treatment

⚠ CAUTION

If calcium chloride is used for waste treatment, an applicable corrosion inhibitor must also be used. Failure to do so may result in damage to system components.

Dirt, scale, products of corrosion, and other foreign material will adversely affect heat transfer between the water and system components. Foreign matter in the chilled-water system can also increase pressure drop and, consequently, reduce water flow. Proper water treatment must be determined locally, depending on the type of system and local water characteristics.

Neither salt nor brackish water is recommended for use in Trane air-cooled Series RT™ chillers. Use of either will lead to a shortened life to an indeterminable degree. Trane encourages the employment of a reputable water treatment specialist, familiar with local water conditions, to assist in this determination and in the establishment of a proper water-treatment program.

⚠ CAUTION

Do not use untreated or improperly-treated water. Equipment damage may occur.

Entering Chilled-Water Piping

- [] Air vents (to bleed air from system).
- [] Water pressure gauges with shutoff valves.
- [] Vibration eliminators.
- [] Shutoff (isolation) valves.
- [] Thermometers (if desired).
- [] Clean out tees.
- [] Pipe strainer.

⚠ CAUTION

Install a strainer in the evaporator-water inlet piping. Failure to do so can result in evaporator tube damage.

Leaving Chilled-Water Piping

- [] Air vents (to bleed air from system).
- [] Water pressure gauges with shutoff valves.
- [] Vibration eliminators.
- [] Shutoff (isolation) valves.
- [] Thermometers.
- [] Clean out tees.
- [] Balancing valve.
- [] Flow Proving Device

⚠ CAUTION

To prevent evaporator damage, do not exceed 150 psig (10.5 bar) evaporator water pressure.

Evaporator Drain

A 1/2" drain connection is located under the outlet end of the evaporator water box. This may be connected to a suitable drain to permit evaporator drainage during unit servicing. A shutoff valve must be installed on the drain line.

Drainage will be done at each end of the 2 water boxes.

In case of winter water drainage for freeze protection, it is compulsory to disconnect the evaporators heaters to protect them from burning due to overheat.

Evaporator Flow Proving Device

Specific connection and schematic wiring diagrams are shipped with the unit. Some piping and control schemes, particularly those using a single water pump for both chilled-water and hot water, must be analyzed to determine how and/or if a flow-sensing device will provide the desired operation.

Flow Switch Installation - typical requirement

1. Mount the switch upright, with a minimum of 5 pipe diameters of straight horizontal run on each side. Do not install close to elbows, orifices, or valves.

Note: The arrow on the switch must point in the direction of flow.

2. To prevent switch fluttering, remove all air from the water system.

Note: The CH.530 provides a 6 second time delay after a "loss-of-flow" diagnostic before shutting the unit down. Contact a qualified service representative if nuisance machine shutdowns persist.

3. Adjust the switch to open when water flow falls below nominal.

Evaporator data is given in the General information Section. Flow-switch contacts are closed on proof of water flow.

4. Install a pipe strainer in the entering evaporator-water line to protect components from waterborne debris.

⚠ CAUTION

Control voltage from the chiller to the flow proving device is 110V ac.

Performance Data

Figure P-18 - Evaporator Water Pressure Drop (SI)

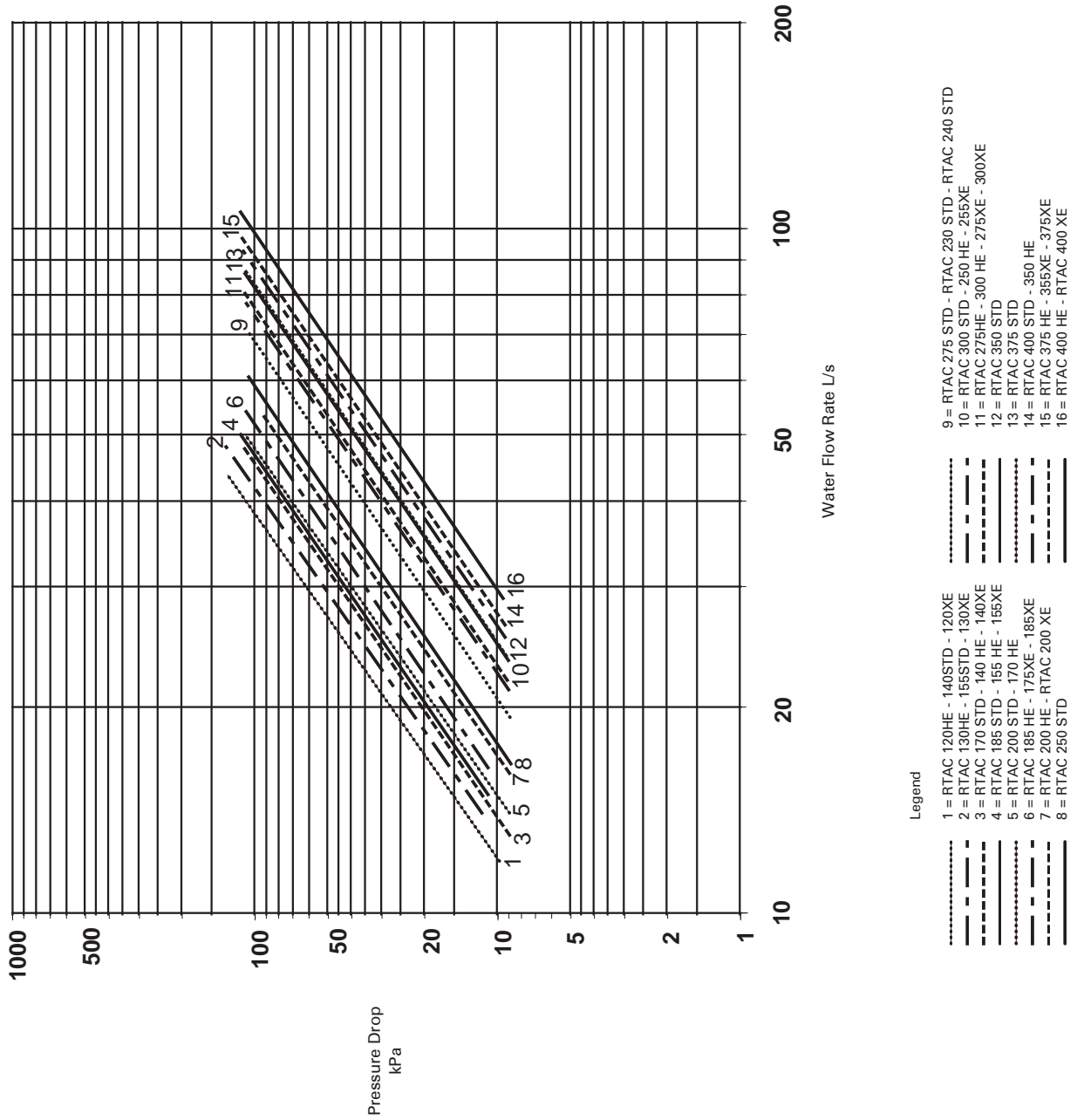

Performance Data

Figure P-19 - Water Side Pressure Drop (English Units)

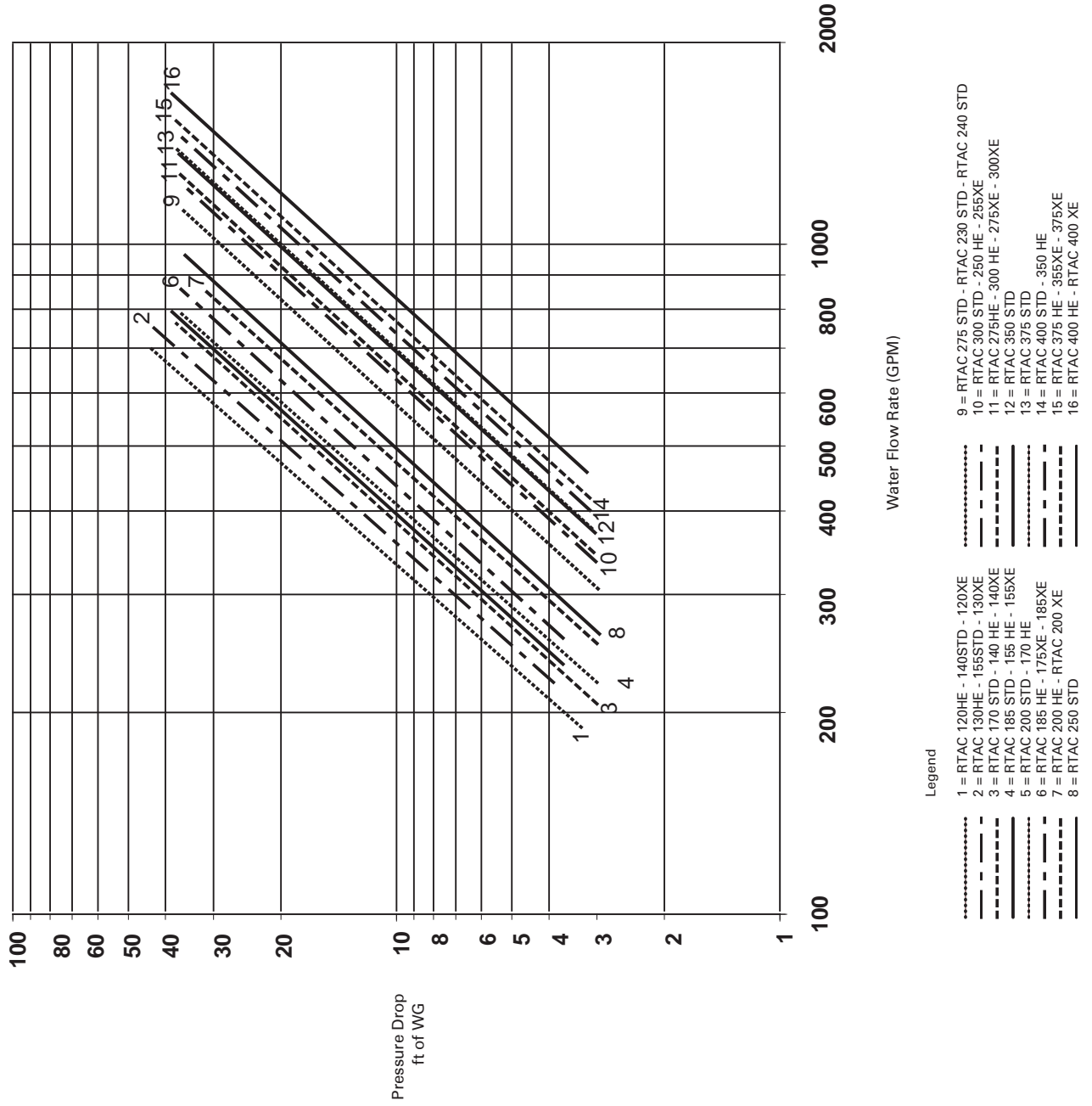

Installation - Mechanical

Water Pressure Gauges

Install field-supplied pressure components as shown in Figure 5. Locate pressure gauges or taps in a straight run of pipe; avoid placement near elbows, and so forth. Be sure to install the gauges at the same elevation on each shell if the shells have opposite-end water connections.

Figure 5 – Suggested Piping for a Typical RTAC Evaporator

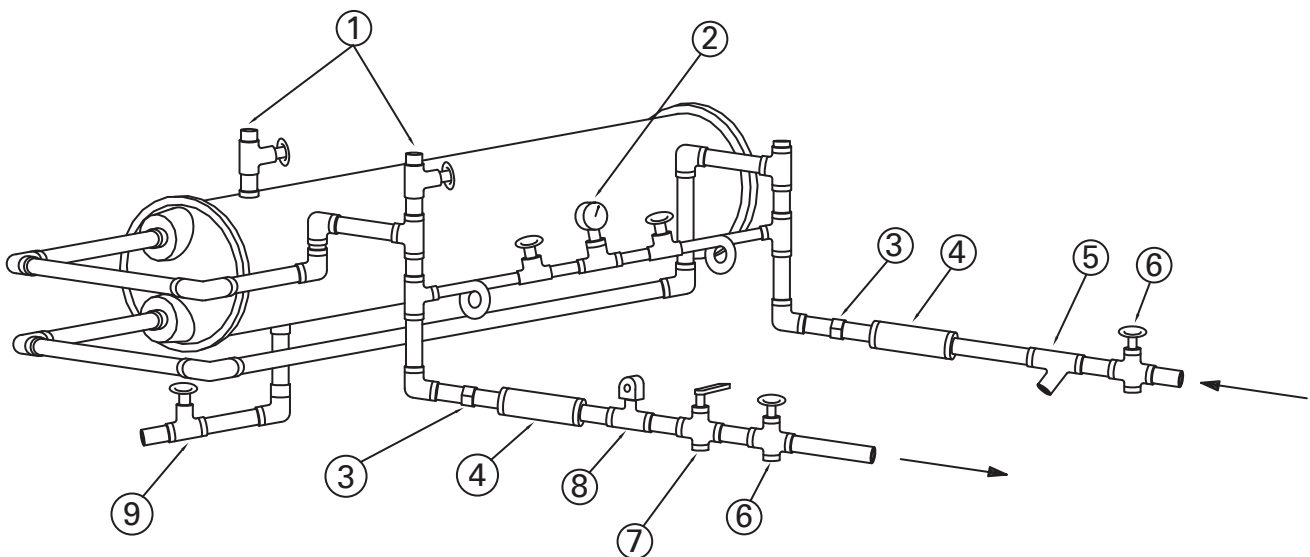

1. Vents
2. Valved Pressure Gauge
3. Union
4. Elastomeric Vibration Eliminator
5. Water Strainer
6. Gate Valve
7. Balancing Valve
8. Flow switch (optional)
9. Drain

Installation - Mechanical

Water Pressure-Relief Valves

⚠ CAUTION

To prevent shell damage, install pressure-relief valves in the evaporator water system.

Install a water pressure-relief valve in the evaporator inlet piping, between the evaporator and the inlet shutoff valve. Water vessels with close-coupled shutoff valves have a high potential for hydrostatic pressure buildup on a water temperature increase. Refer to applicable codes for relief-valve installation guidelines.

Note: After the unit is installed at a site, one vertical (or one diagonal) unit support can be permanently removed if it creates an obstruction for water piping.

Freeze Protection

If the unit will remain operational at subfreezing ambient temperatures, the chilled-water system must be protected from freezing, following the steps listed below.

1. Additional protection must be fitted - contact your Trane Sales Office.
2. Install heat tape on all water piping, pumps, and other components that may be damaged if exposed to freezing temperatures. Heat tape must be designed for low-ambient temperature applications. Heat tape selection should be based on the lowest expected ambient temperature.

3. Add a non-freezing, low-temperature, corrosion-inhibiting, heat-transfer fluid to the chilled-water system. The solution must be strong enough to provide protection against ice formation at the lowest anticipated ambient temperature. Refer to General Data tables for evaporator water storage capacities.

Note: Use of glycol-type antifreeze reduces the cooling capacity of the unit and must be considered in the design of the system specifications.

⚠ CAUTION

With factory-fitted disconnect switch option, evaporator trace heating is taken from the live side of the isolator. As a consequence, the heaters are energized as long as the main switch is closed. Supply voltage to the heating tapes is 400V.

In all cases, the heaters should be energized **ONLY** when the evaporator is fully filled with water. Failure to follow this recommendation will result in heaters fatal burn-out damage due to overheat.

It is compulsory to open the heaters switch to protect them from damage:

- Before the water circuit is drained for maintenance purpose;
- In case of winter water drainage for freeze protection,

The evaporator heaters must be energized as soon as the water circuit is filled to ensure appropriate anti-freeze protection during cold season (see Freeze protection)

⚠ CAUTION

Evaporator damage!

Important: If insufficient concentration or no glycol is used, the evaporator water pumps **must** be controlled by the CH530 to avoid severe damage to the evaporator due to freezing. A power loss of 15 minutes during freezing can damage the evaporator. It is the responsibility of the installing contractor and/or the customer to ensure that a pump will start when called upon by the chiller controls.

Please consult chart 3 for correct concentration of glycol.

The warranty will be void, in case of freezing due to the lack of use of either of these protections.

Installation - Mechanical

Chart 1 - Recommended Low Evaporator Refrigerant Cutout and % of Glycol for RTAC Chillers

Evaporator Fluid Delta T °C	Standard Units							High Efficiency units/Extra efficiency units						
	2	3	4	5	6	7	8	2	3	4	5	6	7	
Chilled Water Set Point														
Leaving Water Temperature Cutout														
Glycol (1) %	1.2	-	3	3	3	4	4	1	1	1	2	2	3	
Glycol (1) Glycol (1) %	-	-	8	9	9	10	-	-	-	7	8	8	9	
Glycol (1) Glycol (1) %	-0.8	-	13	14	15	16	-	-	12	13	14	15	-	
Glycol (1) Glycol (1) %	-2	-4.8	17	18	19	21	-	-	17	18	20	-	-	
Glycol (1) Glycol (1) %	-4	-6.8	21	22	25	-	-	-	21	23	-	-	-	
Glycol (1) Glycol (1) %	-5	-7.8	23	24	-	-	-	-	23	27	-	-	-	
Glycol (1) Glycol (1) %	-6	-8.8	25	28	-	-	-	-	25	-	-	-	-	
Glycol (1) Glycol (1) %	-7	-9.8	27	-	-	-	-	-	28	-	-	-	-	
Glycol (1) Glycol (1) %	-8	-10.8	29	-	-	-	-	-	-	-	-	-	-	
Glycol (1) Glycol (1) %	-9	-11.8	32	-	-	-	-	-	29	-	-	-	-	
Glycol (1) Glycol (1) %	-10	-12.8	-	-	-	-	-	-	31	-	-	-	-	
Glycol (1) Glycol (1) %	-11	-13.8	-	-	-	-	-	-	33	-	-	-	-	
Glycol (1) Glycol (1) %	-12	-14.8	34	-	-	-	-	-	-	-	-	-	-	

Chart 2 - Recommended Low Evaporator Refrigerant Cutout and % of Glycol for RTAC Chillers

Evaporator Fluid Delta T °C	Standard Units							High Efficiency units/Extra efficiency units						
	2	3	4	5	6	7	8	2	3	4	5	6	7	
Chilled Water Set Point														
Leaving Water Temperature Cutout														
Glycol (1) %	1.2	-	3	4	4	5	6	2	2	2	3	4	5	
Glycol (1) Glycol (1) %	-	-	10	11	13	16	-	-	9	10	11	14	-	
Glycol (1) Glycol (1) %	-0.8	-	15	16	19	-	-	-	15	17	-	-	-	
Glycol (1) Glycol (1) %	-2	-4.8	21	-	-	-	-	-	21	-	-	-	-	
Glycol (1) Glycol (1) %	-4	-6.8	-	-	-	-	-	-	-	-	-	-	-	
Glycol (1) Glycol (1) %	-5	-7.8	-	-	-	-	-	-	-	-	-	-	-	
Glycol (1) Glycol (1) %	-6	-8.8	-	-	-	-	-	-	-	-	-	-	-	
Glycol (1) Glycol (1) %	-7	-9.8	-	-	-	-	-	-	-	-	-	-	-	
Glycol (1) Glycol (1) %	-8	-10.8	-	-	-	-	-	-	-	-	-	-	-	

(1) Percent of glycol by weight
 - = Operation is not permitted
CAUTION!
 Glycol concentration should always be equal or higher to the value given in this table. However, if the concentration is much higher than the value given, unit capacity will be uselessly reduced.

Installation - Mechanical

Chart 3 – Recommended Low Evaporator Refrigerant Cutout (LRTC) and % Glycol for RTAC Chillers

% Glycol	Ethylene Glycol		Propylene Glycol	
	Low Refrigerant Temperature Cutout °C	Solution Freeze Point °C	Low Refrigerant Temperature Cutout °C	Solution Freeze Point °C
0	-2.2	0.0	-2.2	0.0
1	-2.4	-0.2	-2.4	-0.2
2	-2.8	-0.6	-2.8	-0.6
3	-3.2	-0.9	-3.1	-0.9
4	-3.5	-1.3	-3.4	-1.2
5	-3.9	-1.7	-3.7	-1.5
6	-4.3	-2.1	-4.1	-1.8
7	-4.7	-2.4	-4.4	-2.2
8	-5.1	-2.8	-4.7	-2.4
9	-5.4	-3.2	-5.0	-2.8
10	-5.8	-3.6	-5.3	-3.1
11	-6.3	-4.1	-5.7	-3.5
12	-6.7	-4.5	-6.1	-3.8
13	-7.2	-4.9	-6.4	-4.2
14	-7.6	-5.4	-6.8	-4.6
15	-8.1	-5.8	-7.2	-4.9
16	-8.6	-6.3	-7.6	-5.3
17	-9.1	-6.8	-8.0	-5.8
18	-9.6	-7.4	-8.4	-6.2
19	-10.1	-7.9	-8.8	-6.6
20	-10.7	-8.4	-9.3	-7.1
21	-11.2	-9.0	-9.8	-7.6
22	-11.8	-9.6	-10.2	-8.0
23	-12.4	-10.2	-10.7	-8.5
24	-13.1	-10.8	-11.3	-9.1
25	-13.7	-11.4	-11.8	-9.6
26	-14.3	-12.1	-12.3	-10.1
27	-15.0	-12.8	-12.9	-10.7
28	-15.7	-13.5	-13.6	-11.3
29	-16.4	-14.2	-14.2	-11.9
30	-17.2	-14.9	-14.8	-12.6
31	-17.9	-15.7	-15.5	-13.3
32	-18.7	-16.5	-16.2	-14.0
33	-19.6	-17.3	-16.9	-14.7
34	-20.4	-18.2	-17.7	-15.5
35	-20.6	-19.1	-18.5	-16.3
36	-20.6	-19.9	-19.3	-17.1
37	-20.6	-20.9	-20.2	-17.9
38	-20.6	-21.8	-20.6	-18.8
39	-20.6	-22.8	-20.6	-19.7
40	-20.6	-23.8	-20.6	-20.7
41	-20.6	-24.8	-20.6	-21.6
42	-20.6	-25.9	-20.6	-22.7
43	-20.6	-27.0	-20.6	-23.7
44	-20.6	-28.1	-20.6	-24.8
45	-20.6	-29.3	-20.6	-25.9
46	-20.6	-30.5	-20.6	-27.1
47	-20.6	-31.7	-20.6	-28.3
48	-20.6	-32.9	-20.6	-29.5
49	-20.6	-34.3	-20.6	-30.8
50	-20.6	-35.6	-20.6	-32.1
51	-20.6	-36.9	-20.6	-33.5
52	-20.6	-38.4	-20.6	-34.9
53	-20.6	-39.8	-20.6	-36.3
54	-20.6	-41.3	-20.6	-37.8

See notes for Chart 3 on following page.

Important! Concentration is based on weight percentage.

Installation - Mechanical

Notes for Chart 3:

1. Solution freeze point is 2.2°C below operating point saturation temperature.
2. LRTC is 2.2°C below freeze point.

Procedure:

1. Is operating condition contained within Chart? If not, see "Specials" below.
2. For leaving-fluid temperatures greater than 4.4°C, use settings for 4.4°C.
3. Select operating conditions from chart. For example: Standard Unit, 3.3°C Delta T, 0°C leaving water temperature.
4. Read off recommended % glycol, for example 16%.
5. Go to Chart 3. From % glycol, select low refrigerant temperature cutout setting, for example -8.6°C.

⚠ CAUTION

1. **Additional glycol beyond the recommendations will adversely effect unit performance. The unit efficiency will be reduced and the saturated evaporator temperature will be reduced. For some operating conditions this effect can be significant.**
2. **If additional glycol is used, then use the actual % glycol to establish the low refrigerant cutout set point.**
3. **The minimum low refrigerant cutout set point allowed is -20.6°C. This minimum is established by the solubility limits of the oil in the refrigerant.**

CAUTION! The recommended flows to achieve a negative temperature are the low limit. In order to guarantee the leaving water temperature, do not allow for temperatures below this limit.

Specials:

1. The following constitute a special that must be calculated by engineering:
 - Freeze inhibitor other than Ethylene Glycol or Propylene Glycol.
 - Fluid Delta T outside of the range of 2°C to 6°C. Unit configurations other than Standard, Standard with extra pass, and High Efficiency.
 - % glycol greater than maximum for a column in Charts 1 and 2. For example: On the Standard unit 6°C Delta T, Ethylene Glycol, the maximum % glycol is 34%.
2. Specials should be calculated by engineering. The purpose of the calculation is to make sure that the design saturated temperature is greater than -16.1°C. Additionally, the calculation must verify that the fluid freeze point is a minimum of 2.2°C lower than the design saturation temperature. The low evaporator temperature cutout will be -2.2°C below the freeze point or -20.6°C, whichever is greater.

Installation – Electrical

General Recommendations

⚠ WARNING

The Warning Label shown in Figure 6 is displayed on the equipment and shown on wiring diagrams and schematics. Strict adherence to these warnings must be observed. Failure to do so may result in personal injury or death.

All wiring must comply with local codes. Specific electrical schematics and connection diagrams are shipped with the unit.

⚠ CAUTION

To avoid corrosion and overheating at terminal connections, use copper mono-conductors only. Failure to do so may result in damage to the equipment. In case of multiconductor cable, an intermediate connection box must be added.

Do not allow conduit to interfere with other components, structural members or equipment. Control voltage (115 V) wiring in conduit must be separate from conduit carrying low voltage (<30 V) wiring.

⚠ CAUTION



Units must not be linked to the neutral wiring of the installation. Units are compatible with the following neutral operating conditions:

TNS	IT	TNC	TT
Standard	Spécial	Spécial	Spécial

⚠ CAUTION

To prevent control malfunctions, do not run low voltage wiring (<30 V) in conduit with conductors carrying more than 30 V.

Figure 6 – Warning Label

 	X39001039-01 Rev. A2
Ouvrir le sectionneur principal avant toute intervention. Certains circuits restent sous tension après coupure du sectionneur principal.	
Bevor mit arbeiten an elektrischen teilen begonnen werden kann, muss der haupschalter geoeffnet werden. Dennoch ist zu beachten, dass bestimmte stromkreise weiterhin spannungsfuehrend sind.	
Open main disconnect switch before servicing any electrical component. Some circuits remain live after opening main disconnect switch.	
Prima di effettuare qualsiasi intervento, aprire il sezionatore principale. Alcuni circuiti rimangono sotto tensione dopo aver aperto il sezionatore principale.	
Voor service aan de koelinstallatie schakel de spanning uit door het uitschakelen van de hoofdschakelaar. Algunos circuitos quedan con tension mantenida despues de la apertura del sectionador.	
Πριν από οποιαδήποτε παρέμβαση ανοίξτε τον κεντρικό αποζευκτήρα. Μετά τη διακοπή του κεντρικού αποζευκτήρα, ορισμένα κυκλώματα παραμένουν υπό τάση.	
Desligar o interruptor principal antes de qualquer intervenção. Alguns circuitos permanecem ligados à corrente depois de o interruptor principal ser desligado.	
Afbryd hovedledningsadskilleren før indgreb. Visse kredse er stadig under spænding, selv efter at hovedledningsadskilleren er afbrudt.	
Öppna huvudfrånskiljaren innan du utför någon annan åtgärd. Vissa kretsängar kan vara strömförande även efter att frånskiljaren har fränkopplats.	
Frakoble hovedbryteren før du gjør noe annet. Enkelte ledninger kann være strömförande selv etter at hovedbryteren er frakoblet.	
Avaä pääkätäisija aina ennen toiminnan käynnistämistä. Pääkätäisijan sulkemisen jälkeen joihinkin virtapiireihin saattaa jäädä jännitettä.	

Wire Sizing

Table J-1 - Customer Wire Selection RTAC 120 - 200

Voltage 400/3/50	Unit without Disconnect Switch	Unit with Disconnect Switch	
	Wire Selection Size to Main Terminal Block	Wire Selection Size to Disconnect Switch	
Unit Size	Maximum cable size mm ²	Disconnect Switch size (Amps)	Maximum cable size mm ²
Standard			
140	2x240	625	2x240
155	2x240	925	2x240
170	2x240	925	2x240
185	2x240	925	2x240
200	2x240	925	2x240
Standard Low Noise			
140	2x240	625	2x240
155	2x240	925	2x240
170	2x240	925	2x240
185	2x240	925	2x240
200	2x240	925	2x240
High Efficiency			
120	2x240	625	2x240
130	2x240	625	2x240
140	2x240	625	2x240
155	2x240	925	2x240
170	2x240	925	2x240
185	2x240	925	2x240
200	2x240	925	2x240
High Efficiency Low Noise			
120	2x240	625	2x240
130	2x240	625	2x240
140	2x240	625	2x240
155	2x240	925	2x240
170	2x240	925	2x240
185	2x240	925	2x240
200	2x240	925	2x240
Extra Efficiency			
120	2x240 mm ²	6x250 + 3x125	2x240 mm ²
130	2x240 mm ²	6x250 + 3x125	2x240 mm ²
140	2x240 mm ²	6x250 + 3x125	2x240 mm ²
155	2x240 mm ²	6x400 + 3x125	2x240 mm ²
175	2x240 mm ²	6x400 + 3x125	2x240 mm ²
185	2x240 mm ²	6x400 + 3x125	2x240 mm ²
200	2x240 mm ²	6x400 + 3x125	2x240 mm ²
Extra Efficiency Low Noise			
120	2x240 mm ²	6x250 + 3x125	2x240 mm ²
130	2x240 mm ²	6x250 + 3x125	2x240 mm ²
140	2x240 mm ²	6x250 + 3x125	2x240 mm ²
155	2x240 mm ²	6x400 + 3x125	2x240 mm ²
175	2x240 mm ²	6x400 + 3x125	2x240 mm ²
185	2x240 mm ²	6x400 + 3x125	2x240 mm ²
200	2x240 mm ²	6x400 + 3x125	2x240 mm ²

Wire Sizing

Table J-2 - Customer Wire Selection RTAC 230 - 400

Voltage 400/3/50	Unit without Disconnect Switch	Unit with Disconnect Switch	
	Wire Selection Size to Main Terminal Block	Wire Selection Size to Disconnect Switch	
Unit Size	Maximum cable size mm ²	Disconnect Switch size (Amps)	Maximum cable size mm ²
Standard			
230	4x240	3x160A + 6x250A + 3x400A	6x240
240	4x240	3x160A + 6x250A + 3x400A	6x240
250	4x240	3x160A + 6x250A + 3x400A	6x240
275	4x240	3x160A + 6x250A + 3x400A	6x240
300	4x240	3x160A + 9x400A	6x240
350	4x240	3x160A + 12x250A	6x240
375	4x240	3x160A + 6x400A + 6x250A	6x240
400	4x240	3x160A + 12x400A	6x240
Standard Low Noise			
230	4x240	3x160A + 6x250A + 3x400A	6x240
240	4x240	3x160A + 6x250A + 3x400A	6x240
250	4x240	3x160A + 6x250A + 3x400A	6x240
275	4x240	3x160A + 6x250A + 3x400A	6x240
300	4x240	3x160A + 9x400A	6x240
350	4x240	3x160A + 12x250A	6x240
375	4x240	3x160A + 6x400A + 6x250A	6x240
400	4x240	3x160A + 12x400A	6x240
High Efficiency			
250	4x240	3x160A + 6x250A + 3x400A	6x240
275	4x240	3x160A + 6x250A + 3x400A	6x240
300	4x240	3x160A + 9x400A	6x240
350	4x240	3x160A + 12x250A	6x240
375	4x240	3x160A + 6x400A + 6x250A	6x240
400	4x240	3x160A + 12x400A	6x240
High Efficiency Low Noise			
250	4x240	3x160A + 6x250A + 3x400A	6x240
275	4x240	3x160A + 6x250A + 3x400A	6x240
300	4x240	3x160A + 9x400A	6x240
350	4x240	3x160A + 12x250A	6x240
375	4x240	3x160A + 6x400A + 6x250A	6x240
400	4x240	3x160A + 12x400A	6x240
Extra Efficiency			
255	4x240	3x160A + 6x250A + 3x400A	6x240
275	4x240	3x160A + 6x250A + 3x400A	6x240
300	4x240	3x160A + 9x400A	6x240
355	4x240	3x160A + 6x400A + 6x250A	6x240
375	4x240	3x160A + 6x400A + 6x250A	6x240
400	4x240	3x160A + 12x400A	6x240
Extra Efficiency Low Noise			
255	4x240	3x160A + 6x250A + 3x400A	6x240
275	4x240	3x160A + 6x250A + 3x400A	6x240
300	4x240	3x160A + 9x400A	6x240
355	4x240	3x160A + 6x400A + 6x250A	6x240
375	4x240	3x160A + 6x400A + 6x250A	6x240
400	4x240	3x160A + 12x400A	6x240*

Note: the material for cables and busbar is copper.

* For RTAC size 400 reduced length, the maximum cable size is 4 x 240 mm²

Electrical Data

Table E-1 - Electrical Data RTAC 120 - 200 (400/3/50)

Unit Size	Quantity	Compressor (Each)				Motor Data				Fans (Each) (6)		Evaporator heater	
		Maximum Amps (3)		Starting Amps (4)		Quantity	kW	FLA	Fan fuse size (A)	Control (VA)	A	kW	
		cmpr 1	cmpr 2	cmpr 1	cmpr 2								
Standard													
140	2	178	178	259	259	8	1.57	3.5	80	860	2.15	2.04	
155	2	214	178	291	259	9	1.57	3.5	80	860	2.15	2.04	
170	2	214	214	291	291	10	1.57	3.5	80	860	2.15	2.04	
185	2	259	214	354	291	11	1.57	3.5	80	860	2.15	2.04	
200	2	259	259	354	354	12	1.57	3.5	80	860	2.15	2.04	
Standard Low Noise													
140	2	178	178	259	259	8	1.57	2.0	80	860	2.15	2.04	
155	2	214	178	291	259	9	1.57	2.0	80	860	2.15	2.04	
170	2	214	214	291	291	10	1.57	2.0	80	860	2.15	2.04	
185	2	259	214	354	291	11	1.57	2.0	80	860	2.15	2.04	
200	2	259	259	354	354	12	1.57	2.0	80	860	2.15	2.04	
High Efficiency													
120	2	147	147	217	217	8	1.57	3.5	80	860	2.15	2.04	
130	2	178	147	259	217	9	1.57	3.5	80	860	2.15	2.04	
140	2	178	178	259	259	10	1.57	3.5	80	860	2.15	2.04	
155	2	214	178	291	259	11	1.57	3.5	80	860	2.15	2.04	
170	2	214	214	291	291	12	1.57	3.5	80	860	2.15	2.04	
185	2	259	214	354	291	13	1.57	3.5	80	860	2.15	2.04	
200	2	259	259	354	354	14	1.57	3.5	80	860	2.15	2.04	
High Efficiency Low Noise													
120	2	147	147	217	217	8	0.75	2.0	80	860	2.15	2.04	
130	2	178	147	259	217	9	0.75	2.0	80	860	2.15	2.04	
140	2	178	178	259	259	10	0.75	2.0	80	860	2.15	2.04	
155	2	214	178	291	259	11	0.75	2.0	80	860	2.15	2.04	
170	2	214	214	291	291	12	0.75	2.0	80	860	2.15	2.04	
185	2	259	214	354	291	13	0.75	2.0	80	860	2.15	2.04	
200	2	259	259	354	354	14	0.75	2.0	80	860	2.15	2.04	
Extra Efficiency													
120	2	147	147	217	217	8	1.57	3.5	80	860	2.15	2.04	
130	2	178	147	259	217	10	1.57	3.5	80	860	2.15	2.04	
140	2	178	178	259	259	10	1.57	3.5	80	860	2.15	2.04	
155	2	214	178	291	259	12	1.57	3.5	80	860	2.15	2.04	
175	2	259	178	354	259	13	1.57	3.5	80	860	2.15	2.04	
185	2	259	214	354	291	14	1.57	3.5	80	860	2.15	2.04	
200	2	259	259	354	354	14	1.57	3.5	80	860	2.15	2.04	
Extra Efficiency Low Noise													
120	2	147	147	217	217	8	0.75	2.0	80	860	2.15	2.04	
130	2	178	147	259	217	10	0.75	2.0	80	860	2.15	2.04	
140	2	178	178	259	259	10	0.75	2.0	80	860	2.15	2.04	
155	2	214	178	291	259	12	0.75	2.0	80	860	2.15	2.04	
175	2	259	178	354	259	13	0.75	2.0	80	860	2.15	2.04	
185	2	259	214	354	291	14	0.75	2.0	80	860	2.15	2.04	
200	2	259	259	354	354	14	0.75	2.0	80	860	2.15	2.04	

Notes:

1. Maximum Compressors FLA + all fans FLA + control Amps
2. Starting Amps of the circuit with the largest compressor circuit including fans plus RLA of the second circuit including fans and control amps
3. Maximum FLA per compressor
4. Compressors starting amps, Star delta start
5. Compressor Power Factor
6. High static fans data - 100Pa ESP - Quantity same as standard fans, power input = 2.21kW each, FLA = 3.9 each

Electrical Data

Table E-1 - Electrical Data RTAC 230 - 400 (400/3/50)

Unit size	Quantity	Compressor (Each)												Fans (Each) (6)				
		Maximum Amps (3)				Starting Amps (4)				Starting amps, Direct on line start (7)				Quantity	kW	FLA	Fans fuse size (A)	Control (VA)
		cmpr 1	cmpr 2	cmpr 3	cmpr 4	cmpr 1	cmpr 2	cmpr 3	cmpr 4	cmpr 1	cmpr 2	cmpr 3	cmpr 4					
Standard																		
230	3	147	147	259	-	217	217	354	-	668	668	1089		14	1.57	3.5	50/50	1720
240	3	178	178	259	-	259	259	354	-	796	796	1089		14	1.57	3.5	50/50	1720
250	3	178	178	259	-	259	259	354	-	796	796	1089		14	1.57	3.5	50/50	1720
275	3	214	214	259	-	291	291	354	-	896	896	1089		16	1.57	3.5	50/50	1720
300	3	259	259	259	-	354	354	354	-	1089	1089	1089		18	1.57	3.5	63/50	1720
350	4	214	214	214	214	291	291	291	291	896	896	896	896	20	1.57	3.5	50/50	1720
375	4	259	259	214	214	354	354	291	291	1089	1089	896	896	22	1.57	3.5	63/50	1720
400	4	259	259	259	259	354	354	354	354	1089	1089	1089	1089	24	1.57	3.5	63/63	1720
Standard Low Noise																		
230	3	147	147	259	-	217	217	354	-	668	668	1089		14	0.75	2.0	50/50	1720
240	3	178	178	259	-	259	259	354	-	796	796	1089		14	0.75	2.0	50/50	1720
250	3	178	178	259	-	259	259	354	-	796	796	1089		14	0.75	2.0	50/50	1720
275	3	214	214	259	-	291	291	354	-	896	896	1089		16	0.75	2.0	50/50	1720
300	3	259	259	259	-	354	354	354	-	1089	1089	1089		18	0.75	2.0	63/50	1720
350	4	214	214	214	214	291	291	291	291	896	896	896	896	20	0.75	2.0	50/50	1720
375	4	259	259	214	214	354	354	291	291	1089	1089	896	896	22	0.75	2.0	63/50	1720
400	4	259	259	259	259	354	354	354	354	1089	1089	1089	1089	24	0.75	2.0	63/63	1720
High Efficiency																		
250	3	178	178	259	-	259	259	354	-	796	796	1089		16	1.57	3.5	50/50	1720
275	3	214	214	259	-	291	291	354	-	896	896	1089		18	1.57	3.5	63/50	1720
300	3	259	259	259	-	354	354	354	-	1089	1089	1089		20	1.57	3.5	80/50	1720
350	4	214	214	214	214	291	291	291	291	896	896	896	896	24	1.57	3.5	63/63	1720
375	4	259	259	214	214	354	354	291	291	1089	1089	896	896	26	1.57	3.5	80/63	1720
400	4	259	259	259	259	354	354	354	354	1089	1089	1089	1089	28	1.57	3.5	80/80	1720
High Efficiency Low Noise																		
250	3	178	178	259	-	259	259	354	-	796	796	1089		16	0.75	2.0	50/50	1720
275	3	214	214	259	-	291	291	354	-	896	896	1089		18	0.75	2.0	63/50	1720
300	3	259	259	259	-	354	354	354	-	1089	1089	1089		20	0.75	2.0	80/50	1720
350	4	214	214	214	214	291	291	291	291	896	896	896	896	24	0.75	2.0	63/63	1720
375	4	259	259	214	214	354	354	291	291	1089	1089	896	896	26	0.75	2.0	80/63	1720
400	4	259	259	259	259	354	354	354	354	1089	1089	1089	1089	28	0.75	2.0	80/80	1720
Extra Efficiency																		
255	3	178	178	259	-	259	259	354	-	796	796	1089		16	1.57	3.5	50/50	1720
275	3	214	214	259	-	291	291	354	-	896	896	1089		20	1.57	3.5	63/50	1720
300	3	259	259	259	-	354	354	354	-	1089	1089	1089		22	1.57	3.5	80/50	1720
355	4	259	259	178	178	354	354	259	259	1089	1089	796	796	24	1.57	3.5	80/63	1720
375	4	259	259	214	214	354	354	291	291	1089	1089	896	896	26	1.57	3.5	80/63	1720
400	4	259	259	259	259	354	354	354	354	1089	1089	1089	1089	28	1.57	3.5	80/80	1720
Extra Efficiency Low Noise																		
255	3	178	178	259	-	259	259	354	-	796	796	1089		16	0.75	2.0	50/50	1720
275	3	214	214	259	-	291	291	354	-	896	896	1089		20	0.75	2.0	63/50	1720
300	3	259	259	259	-	354	354	354	-	1089	1089	1089		22	0.75	2.0	80/50	1720
355	4	259	259	178	178	354	354	259	259	1089	1089	796	796	24	0.75	2.0	80/63	1720
375	4	259	259	214	214	354	354	291	291	1089	1089	896	896	26	0.75	2.0	80/63	1720
400	4	259	259	259	259	354	354	354	354	1089	1089	1089	1089	28	0.75	2.0	80/80	1720

Electrical Data

Table E-2 - Electrical Data RTAC 120 - 200 Unit Wiring (400/3/50)

Motor Data							
Compressor (Each)							
Unit size	Number of Power Connections	Maximum Amps (1)	Starting Amps (2)	Starting Amps (2) (7) Direct on line start	Power Factor (5)	Compressor Fuse Size (A)	Short Circuit Rating (kA)
Standard							
140	1	386	424	961	0.89	200-200	35
155	1	426	460	1065	0.89	315-250	35
170	1	465	490	1095	0.89	315-315	35
185	1	514	557	1292	0.89	315-315	35
200	1	562	594	1329	0.89	315-315	35
230	1	606	629	1364	0.89	250-250/315	35
240	1	668	677	1412	0.89	250-250/315	35
250	1	668	677	1412	0.89	250-250/315	35
275	1	747	738	1473	0.89	250-250/315	35
300	1	844	813	1548	0.89	315-315/315	35
350	1	930	851	1456	0.89	250-250/250-250	35
375	1	1027	955	1690	0.89	315-315/250-250	35
400	1	1124	1030	1765	0.89	315-315/315-315	35
Standard Low Noise							
140	1	374	412	949	0.89	200-200	35
155	1	412	446	1051	0.89	315-250	35
170	1	450	475	1080	0.89	315-315	35
185	1	497	540	1275	0.89	315-315	35
200	1	544	576	1311	0.89	315-315	35
230	1	585	608	1343	0.89	250-250/315	35
240	1	647	656	1391	0.89	250-250/315	35
250	1	647	656	1391	0.89	250-250/315	35
275	1	723	714	1449	0.89	250-250/315	35
300	1	817	786	1521	0.89	315-315/315	35
350	1	900	821	1426	0.89	250-250/250-250	35
375	1	994	922	1657	0.89	315-315/250-250	35
400	1	1088	994	1729	0.89	315-315/315-315	35
High Efficiency							
120	1	324	358	809	0.89	200-200	35
130	1	359	404	941	0.89	200-200	35
140	1	393	431	968	0.89	200-200	35
155	1	433	467	1072	0.89	315-250	35
170	1	472	497	1102	0.89	315-315	35
185	1	521	564	1299	0.89	315-315	35
200	1	569	601	1336	0.89	315-315	35
250	1	675	684	1419	0.89	250-250/315	35
275	1	754	745	1480	0.89	250-250/315	35
300	1	851	820	1551	0.89	315-315/315	35
350	1	944	865	1470	0.89	250-250/250-250	35
375	1	1041	969	1704	0.89	315-315/250-250	35
400	1	1138	1044	1779	0.89	315-315/315-315	35

Electrical Data

Table E-2 - Electrical Data RTAC 120 - 200 Unit Wiring (400/3/50)

Motor Data							
Unit size	Number of Power Connections	Maximum Amps (1)	Compressor (Each)		Power Factor (5)	Compressor Fuse Size (A)	Short Circuit Rating (kA)
			Starting Amps (2)	Starting Amps (2) (7) Direct on line start			
Standard							
High Efficiency Low Noise							
120	1	312	346	797	0.89	200-200	35
130	1	345	390	927	0.89	200 -200	35
140	1	378	416	953	0.89	200-200	35
155	1	416	450	1055	0.89	315-250	35
170	1	454	479	1084	0.89	315-315	35
185	1	501	544	1279	0.89	315-315	35
200	1	548	580	1315	0.89	315-315	35
250	1	651	660	1395	0.89	250-250/315	35
275	1	727	718	1453	0.89	250-250/315	35
300	1	821	790	1525	0.89	315-315/315	35
350	1	908	829	1434	0.89	250-250/250-250	35
375	1	1002	930	1665	0.89	315-315/250-250	35
400	1	1096	1002	1737	0.89	315-315/315-315	35
Extra Efficiency							
120	1	324	358	809	0.89	200-200	35
130	1	362	407	944	0.89	200 -200	35
140	1	393	431	968	0.89	200-200	35
155	1	436	470	1075	0.89	315-250	35
175	1	485	537	1272	0.89	315-250	35
185	1	524	567	1302	0.89	315-315	35
200	1	569	601	1336	0.89	315-315	35
255	1	675	684	1419	0.89	250-250/315	35
275	1	761	752	1487	0.89	250-250/315	35
300	1	858	827	1562	0.89	315-315/315	35
355	1	962	908	1643	0.89	315-315/250-250	35
375	1	1041	969	1704	0.89	315-315/250-250	35
400	1	1138	1044	1779	0.89	315-315/315-315	35
Extra Efficiency Low Noise							
120	1	312	346	797	0.89	200-200	35
130	1	347	392	929	0.89	200 -200	35
140	1	378	416	953	0.89	200-200	35
155	1	418	452	1057	0.89	315-250	35
175	1	465	517	1252	0.89	315-250	35
185	1	503	546	1281	0.89	315-315	35
200	1	548	580	1315	0.89	315-315	35
255	1	651	660	1395	0.89	250-250/315	35
275	1	731	722	1457	0.89	250-250/315	35
300	1	825	794	1529	0.89	315-315/315	35
355	1	926	872	1607	0.89	315-315/250-250	35
375	1	1002	930	1665	0.89	315-315/250-250	35
400	1	1096	1002	1737	0.89	315-315/315-315	35

Installation – Electrical

Installer-Supplied Components

⚠ CAUTION

Customer wiring interface connections are shown in the electrical schematics and connection diagrams that are shipped with the unit. The installer must provide the following components if not ordered with the unit:

- [] Power supply wiring (in conduit) for all field-wired connections.
- [] All control (interconnecting) wiring (in conduit) for field-supplied devices.
- [] Fused-disconnect switches or HACR-type circuit breakers.
- [] Power-factor-correction capacitors.

Power-Supply Wiring

All power-supply wiring must be sized and selected by the project engineer in accordance with EN 60204.

⚠ WARNING

To prevent injury or death, disconnect all electrical power sources before completing wiring connections to the unit.

All wiring must comply with local codes. The installing (or electrical) contractor must provide and install the system interconnecting wiring, as well as the power supply wiring. It must be properly sized and equipped with the appropriate fused-disconnect switches.

The type and installation location(s) of the fused-disconnect switches must comply with all applicable codes.

⚠ CAUTION

Use only copper mono-conductors to avoid corrosion and overheating at terminal connections.

Cut holes into the sides of the control panel for the appropriately-sized power wiring conduits. The wiring is passed through these conduits and connected to the terminal blocks, optional unit-mounted disconnects, or HACR-type breakers.

To provide proper phasing of 3 phase input, make connections as shown in field wiring diagrams and as stated on the yellow WARNING label in the starter panel. For additional information on proper phasing, refer to "Unit Voltage Phasing." Proper equipment grounds must be provided to each ground connection in the panel (one for each customer-supplied conductor per phase).

Control Power Supply

The unit is equipped with a control power transformer; it is not necessary to provide additional control power voltage to the unit.

Heater Power Supply

The evaporator shell is insulated from ambient air and protected from freezing for temperatures down to -29°C [-20,2°F] by two thermostatically-controlled immersion heaters and two strip heaters combined with evaporator pumps activation through CH530. Whenever the ambient temperature drops to approximately 4°C [39.2°F], the thermostat energizes the heaters and the CH530 activates the pumps..

For temperatures below -29°C, please contact your local Trane sales engineer for advice.

⚠ CAUTION

The control panel main processor does not check for loss of power to the heat tape nor does it verify thermostat operation. A qualified technician must verify power to the heat tape and confirm operation of the heat tape thermostat, to avoid catastrophic damage to the evaporator.

⚠ CAUTION

With factory-fitted disconnect switch, trace heating is taken from the live side of the isolator so power remains on. Supply voltage to the the heating tapes is 400V. In case of winter water drainage for freeze protection, it is compulsory to disconnect the evaporators heaters to protect them from burning due to overheat.

Installation – Electrical

Water Pump Power Supply

Provide power-supply wiring with fused disconnect switch(es) for the chilled-water pump(s).

Interconnecting Wiring

Chilled-Water Flow (Pump) Interlock

The Model RTAC Series R™ chiller requires a field-supplied, control-voltage contact input through a flow proving switch (6S56) and an auxiliary contact (6K51). Connect the proving switch and auxiliary contact to (6X1) and (A7-2) or (A7-3). Refer to the field wiring for details.

Chilled-Water Pump Control

An evaporator water-pump output relay closes when the chiller is given a signal to go into the AUTO mode of operation from any source. The contact is opened to turn off the pump in the event of most machine-level diagnostics, to prevent the buildup of pump heat.

⚠ CAUTION

This evaporator water pump output relay must be used to control the chilled water pump and to benefit from the water pump timer function at startup and shutdown of the chiller. This is required when the chiller is in operation under freezing conditions, especially if the chilled water loop does not contain glycol.

⚠ CAUTION

Refer to Freeze Protection section for information about the evaporator circulating pump.

The relay output from (A5-2) or (A5-3) is required to operate the evaporator water-pump (CHWP) contactor. Contacts should be compatible with a 115/230 V (ac) control circuit. The CHWP relay operates in different modes depending on CH.530 or Tracer commands, if available, or service pumpdown (see maintenance section). Normally, the CHWP relay follows the AUTO mode of the chiller. Whenever the chiller has no diagnostics and is in the AUTO mode, regardless of where the auto command is coming from, the normally-open relay is energized. When the chiller exits the AUTO mode, the relay is timed open for an adjustable (using TechView) 0 to 30 minutes. The non-AUTO modes in which the pump is stopped include Reset (88), Stop (00), External Stop (100), Remote Display Stop (600), Stopped by Tracer (300), Low-Ambient Run Inhibit (200), and Ice-Building complete (101).

Table 12 – Pump Relay Operation

Chiller Mode	Relay Operation
Auto	Instant close
Ice Building	Instant close
Tracer Override	Close
Stop	Timed Open
Ice Complete	Instant Open
Diagnostics	Instant Open*

*Exceptions noted in paragraphs following

When going from STOP to AUTO, the CHWP relay is energized immediately. If evaporator water flow is not established in 4 minutes and 15 seconds, the CH.530 de-energizes the CHWP relay and generates a non-latching diagnostic. If flow returns (for example, someone else is controlling the pump), the diagnostic is cleared, the CHWP is re-energized, and normal control is resumed.

If evaporator water flow is lost after it has been established, the CHWP relay remains energized and a non-latching diagnostic is generated. If flow returns, the diagnostic is cleared and the chiller returns to normal operation.

In general, when there is either a non-latching or latching diagnostic, the CHWP relay is turned off as though there was a zero-time delay. Exceptions (see Table 12) whereby the relay continues to be energized occur with:

1. A Low Chilled-Water Temperature diagnostic (non-latching) (unless also accompanied by an Evaporator Leaving-Water Temperature Sensor Diagnostic)
- or
2. A starter-contactor interrupt-failure diagnostic, in which a compressor continues to draw current even after commanded to shut down
- or
3. A Loss of Evaporator Water Flow diagnostic (non-latching) and the unit is in the AUTO mode, after initially having proven evaporator water flow.

Installation – Electrical

Alarm and Status Relay Outputs (Programmable Relays)

A programmable relay concept provides for enunciation of certain events or states of the chiller, selected from a list of likely needs, while only using four physical output relays as shown in the field wiring diagram. The four relays are provided (generally with a Quad Relay Output LLID) as part of the Alarm Relay Output. The relay contacts are isolated Form C (SPDT), suitable for use with 120 V (ac) circuits drawing up to 2.8 A inductive, 7.2 A resistive, or 240 W and for 240 V (ac) circuits drawing up to 0.5 A resistive.

The list of events or states that can be assigned to the programmable relays follows. The relay will be energized when the events or state occurs.

Table 13 – Alarm and Status Relay Output Configuration Table

	Description
Alarm - Latching	This output is true whenever there is any active diagnostic that requires a manual reset to clear, that affects the chiller, the circuit, or any of the compressors on a circuit. This classification does not include informational diagnostics.
Alarm - Auto Reset	This output is true whenever there is any active diagnostic that could automatically clear, that affects the chiller, the circuit, or any of the compressors on a circuit. This classification does not include informational diagnostics.
Alarm	This output is true whenever there is any diagnostic affecting any component, whether latching or automatically clearing. This classification does not include informational diagnostics.
Alarm Circuit 1	This output is true whenever there is any diagnostic effecting Refrigerant Circuit 1, whether latching or automatically clearing, including diagnostics affecting the entire chiller. This classification does not include informational diagnostics.
Alarm Circuit 2	This output is true whenever there is any diagnostic affecting Refrigerant Circuit 2, whether latching or automatically clearing, including diagnostics effecting the entire chiller. This classification does not include informational diagnostics.
Chiller Limit Mode (with a 20 minute filter)	This output is true whenever the chiller has been running in one of the unloading types of limit modes (condenser, evaporator, current limit or phase imbalance limit) continuously for the last 20 minutes.
Circuit 1 Running	This output is true whenever any compressors are running (or commanded to be running) on Refrigerant Circuit 1, and false when no compressors are commanded to be running on that circuit.
Circuit 2 Running	This output is true whenever any compressors are running (or commanded to be running) on Refrigerant Circuit 2, and false when no compressors are commanded to be running on that circuit.
Chiller Running	This output is true whenever any compressors are running (or commanded to be running) on the chiller and false when no compressors are commanded to be running on the chiller.
Maximum Capacity (Software 18.0 or higher)	This output is true whenever the chiller has reached maximum capacity or had reached its maximum capacity and since that time has not fallen below 70% average current relative to the rated ARI current for the chiller. The output is false when the chiller falls below 70% average current and, since that time, had not reestablished maximum capacity.

Installation – Electrical

Relay Assignments Using TechView

The CH.530 Service Tool (TechView) is used to assign any of the above list of events or status to each of the four relays provided. The relays to be programmed are referred to by the terminal numbers for the relay on the LLID board (A4-5).

The default assignments for the four available relays of the RTAC Alarm and Status Package are:

Table 14– Default Assignments

Relay 1	
Terminals J2 -12,11,10:	Alarm
Relay 2	
Terminals J2 - 9,8,7:	Chiller Running
Relay 3	
Terminals J2-6,5,4:	Maximum Capacity
Relay 4	
Terminals J2-3,2,1:	Chiller Limit

If any of the Alarm and Status relays are used, provide electrical power, 115 V or 24V (ac) with a fused-disconnect switch, to the panel and wire them through the appropriate relays (terminals on A4-3). Provide wiring (switched hot, neutral, and ground connections) to the remote annunciation devices. Do not use power from the control panel transformer on the chiller to power these remote devices. Refer to the field diagrams that are shipped with the unit.

Low-Voltage Wiring

The remote devices described below require low-voltage wiring. All wiring to and from these remote input devices to the control panel must be made with shielded, twisted-pair conductors. Be sure to ground the shielding only at the panel.

CAUTION

To prevent control malfunctions, do not run low-voltage wiring (<30 V) in conduit with conductors carrying more than 30 V.

Emergency Stop

The CH.530 provides auxiliary control for a customer-specified and -installed latching tripout. When this customer-furnished remote contact (6S3) is provided, the chiller will run normally when the contact is closed. When the contact opens, the unit will trip off on a manually-resettable diagnostic. This condition requires manual reset at the chiller switch on the front of the control panel.

Connect low-voltage leads to terminal strip locations on (A6-1). Refer to the field diagrams that are shipped with the unit.

Silver- or gold-plated contacts are recommended. These customer-furnished contacts must be compatible with a 24 V (dc), 12 mA resistive load.

External Auto/Stop

If the unit requires the external Auto/Stop function, the installer must provide leads from the remote contacts (6S1) to the proper terminals of the (A6-1) on the control panel.

The chiller will run normally when the contacts are closed. When either contact opens, the compressor(s), if operating, will go to the RUN:UNLOAD operating mode and cycle off. Unit operation will be inhibited. Re-closure of the contacts will permit the unit to automatically return to normal operation.

Field-supplied contacts for all low-voltage connections must be compatible with dry circuit 24 V (dc) for a 12 mA resistive load. Refer to the field diagrams that are shipped with the unit.

Installation – Electrical

External Circuit Lockout – Circuit Number 1 and Circuit Number 2

The CH.530 provides auxiliary control of a customer-specified or -installed contact closure, for individual operation of either Circuit Number 1 or Number 2. If the contact is closed, the refrigerant circuit will not operate (6S6 and 6S7).

Upon contact opening, the refrigerant circuit will run normally. This feature is used to restrict total chiller operation, e.g., during emergency generator operations.

External Circuit Lockout will only function if it is enabled using TechView.

Connections to (A6-2) are shown in the field diagrams that are shipped with the unit.

These customer-supplied contact closures must be compatible with a 24 V (dc), 12 mA resistive load. Silver- or gold-plated contacts are recommended.

Ice-Building Option

The CH.530 provides auxiliary control for a customer-specified and -installed contact closure for ice building, if so configured and enabled. This output is known as the Ice-Building Status Relay. The normally-open contact will be closed when ice building is in progress and open when ice building has been normally terminated, either through the Ice Termination set point being reached or removal of the Ice Building command. This output is for use with the ice-storage system equipment or controls (provided by others), to signal the system changes required as the chiller mode changes from “ice building” to “ice complete.” When contact (6S55) is provided, the chiller will run normally when the contact is open.

CH.530 will accept either an isolated contact closure (External Ice-Building command) or a Remote Communicated input (Tracer) to initiate and command the Ice-Building mode.

CH.530 also provides a “Front Panel Ice-Termination Set Point,” settable through TechView, and adjustable from 20 to 31°F [-6.7 to -0.5°C] in at least 1°F [1°C] increments.

Note: When in the Ice-Building mode, and the evaporator entering-water temperature drops below the ice termination set point, the chiller terminates the Ice-Building mode and changes to the Ice-Building-Complete Mode.

⚠ CAUTION

Freeze inhibitor must be adequate for the leaving-water temperature. Failure to do so will result in damage to system components.

TechView must also be used to enable or disable Ice Machine Control. This setting does not prevent the Tracer from commanding Ice-Building mode.

Upon contact closure, the CH.530 will initiate an ice-building mode, in which the unit runs fully loaded at all times. Ice building shall be terminated either by opening the contact or based on the entering evaporator-water temperature. CH.530 will not permit the ice-building mode to be reentered until the unit has been switched out of ice-building mode (open 6S55 contacts) and then switched back into ice-building mode (close 6S55 contacts.)

In ice building, all limits (freeze avoidance, evaporator, condenser, and current) will be ignored. All safeties will be enforced.

If, while in ice-building mode, the unit gets down to the freezestat setting (water or refrigerant), the unit will shut down on a manually resettable diagnostic, just as in normal operation.

Connect leads from (6S55) to the proper terminals of (A6-3). Refer to the field diagrams that are shipped with the unit.

Silver- or gold-plated contacts are recommended. These customer-furnished contacts must be compatible with a 24 V (dc), 12 mA resistive load.

Installation – Electrical

Optional External Chilled-Water Set Point (ECWS):

The CH.530 provides inputs that accept either 4-20 mA or 2-10 V (dc) signals to set the external chilled-water set point (ECWS). This is not a reset function. The input defines the set point. This input is primarily used with generic BAS (building automation systems). The chilled-water set point can also be changed through Tracer.

The chilled-water set point may be changed from a remote location by sending either a 2-10 V (dc) or 4-20 mA signal to the (A2-1) module. 2-10 V (dc) and 4-20 mA each correspond to a 10°F to 65°F [-12°C to 18°C] external chilled-water set point.

The ECWS LLID only reports either current or voltage. The value can be considered either.

If the ECWS LLID develops an open or short, the LLID will report either a very high or very low value back to the controller. This will generate an informational diagnostic and the unit will default to using the Front Panel Chilled-Water Set Point.

TechView is used to install or remove the External Chilled-Water Set Point option as well as a means to enable and disable ECWS.

The following equations apply:

As generated from external source
 As processed by CH.530

Voltage Signal

$$V \text{ (dc)} = 0.1455 * (\text{ECWS}) + 0.5454$$

$$\text{ECWS} = 6.875 * (V \text{ (dc)}) - 3.75$$

Current Signal

$$\text{mA} = 0.2909 * (\text{ECWS}) + 1.0909$$

$$\text{ECWS} = 3.4375 * (\text{mA}) - 3.75$$

ECWS vs Input (VDC)

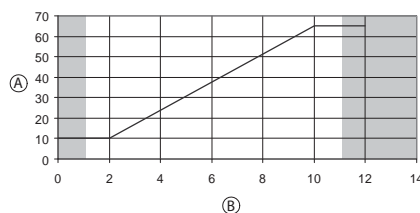

ECWS versus Input (mA)

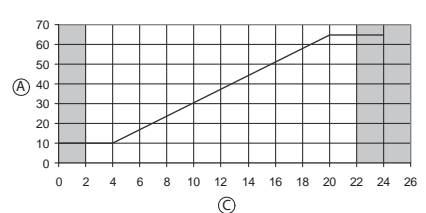

A = ECWS
 B = Input (VDC)
 C = Input (mA)

■ = Out of range diagnostic

Optional Current Limit Setpoint

Setpoint (CLS). This is not a reset function; the input level defines the setpoint. This input will primarily used with Generic BAS systems (Building Automation Systems). The current limit setpoint can also be changed over the communications link.

Note: RTAC because of the nature of the unloading capabilities of its compressors, uses an adjustment range of 60 to 120% rather than 40 to 120% range per other products.

The current limit setpoint may be changed from a remote location by sending either a 2-10 VDC or 4-20 mA to the (A2-1) module. 2-10 VDC and 4-20 mA each correspond to a 60 to 120% RLA range for RTAC units using GP2 compressors.

The ECLS LLID only reports either current or voltage. The value can be considered either:

- In range, e.g. 4-20 mA or 2-10 VDC,
- Under or over range and clamped (by the MP),
- Severely under or over range and clamped but considered an open or short (by the MP).

The ECLS LLID reports either a very low or very high value when there is

either an open or short in the system.

When an open or short is detected (or the signal is severely beyond the valid range) on the 2-10 VDC or 4-20 mA ECLS input and when the ECLS option is installed (and per the design implementation, enabled) an informational diagnostic is generated. The active current limit setpoint defaults to the panel (or next priority) current limit setpoint. Open and short criteria set as close to the end of range values as possible and still reliably detect an open and short.

TechView provides a configuration means to install or not install the External Current Limit Setpoint option. TechView also provides a means to enable and disable ECLS.

Installation – Electrical

The following equations apply:

For RTAC Units	Voltage Signal	Current Signal
As generated from external source	$V_{dc} = 0.133 * (\%) - 6.0$	$mA = 0.266 * (\%) - 12.0$
As processed by Tracer CH530	$\% = 7.5 * (VDC) + 45.0$	$\% = 3.75 * (mA) + 45.0$

As a graph this yields the following:

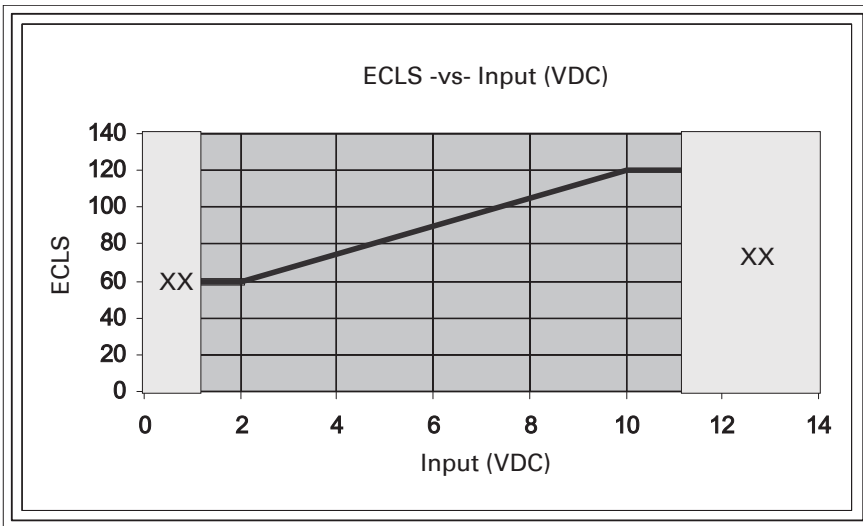

For input signals beyond the 2-10VDC or 4-20mA range, the end of range value is used. For example, if the customer inputs 21 mA, the ECLS limits it self to the corresponding 20 mA ECLS.

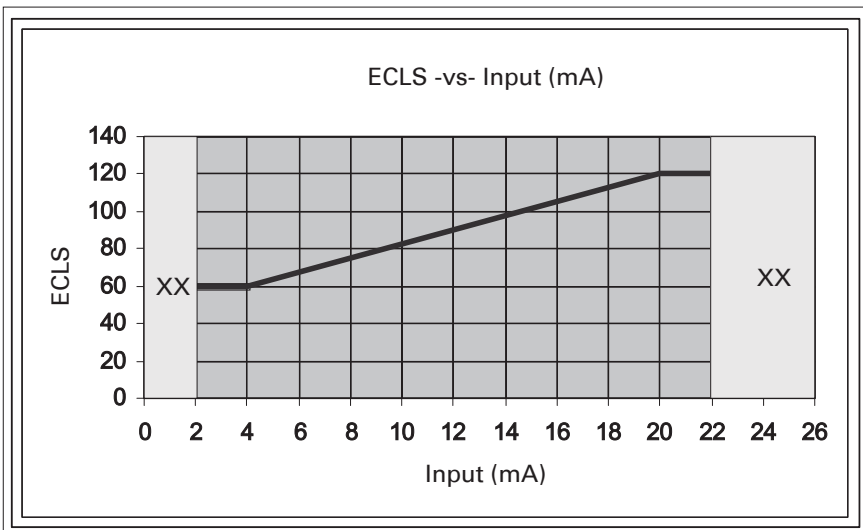

XX = Out of range diagnostic
I = Input
ECLS = External Current Limit Setpoint
VDC = Volt Direct Current
mA = milliamps

Installation – Electrical

Optional Tracer Comm 3 Interface

This option allows the Tracer CH.530 controller to exchange information (for example, operating set points and Auto/Standby commands) with a higher-level control device, such as a Tracer Summit or a multiple-machine controller. A shielded, twisted-pair connection establishes the bi-directional communications link between the Tracer CH.530 and the building automation system.

⚠ CAUTION

To prevent control malfunctions, do not run low voltage wiring (<30 V) in conduit with conductors carrying more than 30 V.

Field wiring for the communication link must meet the following requirements:

1. All wiring must be in accordance with the IEC and local codes.
2. Communication link wiring must be shielded, twisted-pair wiring. See the table below for wire size selection:

Wire Size	Maximum Length of Communication Wire
2.5 mm ²	1500 m
1.5 mm ²	600 m
1.0 mm ²	300 m

3. The maximum total wire length for each communication link is 1500 m.
4. The communication link cannot pass between buildings.
5. All units on the communication link can be connected in a "daisy chain" configuration.

Communication Link Connection Procedure

1. Refer to the Tracer installation literature to determine proper communication-link termination connections at the Tracer or Summit panel.
2. Connect the shield of the communication-link wiring to the designated shield terminal at the Tracer or Summit panel.
3. Install a Tracer Comm 3 Interface LLID in the chiller control panel if one has not already been installed.
4. Connect the twisted-pair leads from the BAS, or from the previous unit on the "daisy chain," to the proper terminals of the Tracer Comm 3 Interface LLID (A9). There is no polarity requirement for this connection.
5. At the CH.530, the shield should be cut and taped to prevent any contact between the shield and ground.

Note: On multiple-unit installations, splice the shielding of the two twisted-pair wires coming into each unit in the "daisy chain" system. Tape the spliced connections to prevent any contact between the shield and ground. At the last unit in the chain, the shield should be cut and taped.

6. Connect TechView to the Tracer CH.530 controller.
7. Look at the Feature tab in Configuration View-Custom Tab in TechView and verify that the "REM – Remote Interface" digit of the chiller's model number has been configured as "C - Tracer Comm 3 Interface." If the Tracer Comm 3 Interface option is not selected, select it, select the Load Configuration button at the bottom of the screen, and go into Binding View and make sure the Comm 3 Interface LLID is bound and communicating properly.
8. Look at the Configuration View in TechView and verify that the Comm 3 ICS address is set correctly. The Comm 3 ICS address setting can be found under the Custom tab. This selection will only appear under the Custom tab in the Configuration View if the Comm 3 Interface LLID has been correctly installed in step five above.
9. Go to the Unit View in TechView and select the "Auto-Remote" radio button. This will give set point priority to the BAS that is connected to the unit.

Installation – Electrical

LonTalk® Communications Interface for Chillers (LCI-C)

CH.530 provides an optional LonTalk Communication Interface (LCI-C) between the chiller and a Building Automation System (BAS). An LCI-C LLID shall be used to provide "gateway" functionality between a LonTalk compatible device and the chiller. The inputs/outputs include both mandatory and optional network variables as established by the LonMark Functional Chiller Profile 8040.

Installation Recommendations

- 22 AWG 0.5 mm² Level 4 unshielded communication wire recommended for most LCI-C installations
- LCI-C link limits: 1400 m, 60 devices
- Termination resistors are required
 - 105 ohms at each end for Level 4 wire
 - 82 ohms at each end for Trane "purple" wire
- LCI-C topology should be daisy chain
- Zone sensor communication stubs limited to 8 per link, 15 m each (maximum)
- One repeater can be used for an additional 1400 m, 60 devices, 8 communication stubs

LonTalk Points List

Inputs	Variable type		SNVT_Type
Chiller Enable/Disable	binary	start(1)/stop(0)	SNVT_switch
Chilled Water Setpoint	analog	temperature	SNVT_temp_p
Current Limit Setpoint	analog	% current	SNVT_lev_percent
Chiller Mode	(1)		SNVT_hvac_mode
Outputs			
Chiller On/Off	binary	on(1)/off(0)	SNVT_switch
Active Chilled Water Setpoint	analog	temperature	SNVT_temp_p
Percent RLA	analog	% current	SNVT_lev_percent
Active Current Limit Setpoint	analog	% current	SNVT_lev_percent
Leaving Chilled Water Temperature	analog	temperature	SNVT_temp_p
Entering Chilled Water Temperature	analog	temperature	SNVT_temp_p
Entering Condenser Water Temperature	analog	temperature	SNVT_temp_p
Leaving Condenser Water Temperature	analog	temperature	SNVT_temp_p
Alarm Description	(2)		SNVT_str_asc
Chiller Status	(3)		SNVT_chlr_status

(1) Chiller Mode is used to place the chiller into an alternate mode; Cool or Ice Build

(2) Alarm Description denotes alarm severity and target.

Severity: no alarm, warning, normal shutdown, immediate shutdown

Target: Chiller, Platform, Ice Building (Chiller is refrigerant circuit and Platform is control circuit)

(3) Chiller Status describes Chiller Run Mode and Chiller Operating Mode.

Run Modes: Off, Starting, Running, Shutting Down

Operating Modes: Cool, Ice Build

States: Alarm, Run Enabled, Local Control, Limited, CHW Flow, Cond Flow

Operating Principles

Figure 7 – System Schematic

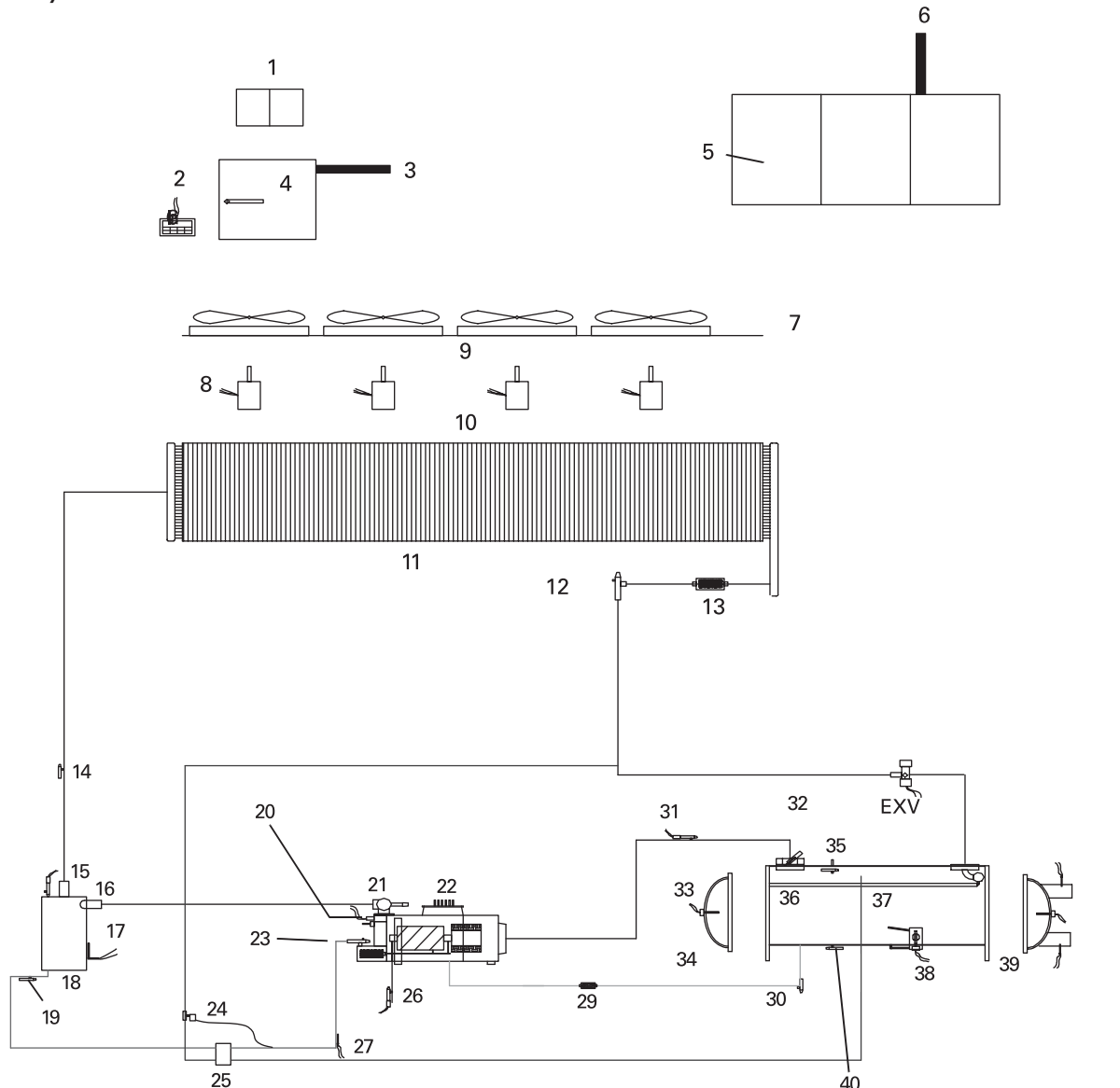

- | | | |
|--|---|--|
| 1. Variable-Speed Fan Inverter (optional) | 15. Discharge Pressure Transducer | 30. Oil Return Shutoff |
| 2. EasyView (or DynaView) Interface | 16. Relief Valve | 31. Suction Pressure Transducer |
| 3. To Fans | 17. Heater | 32. Suction Isolation Valve (option) |
| 4. Control Panel (Fans, Fuses) | 18. Oil Separator | 33. Heater |
| 5. Control Panel (Starters, Breakers, Transformer) | 19. Oil Drain Valve | 34. Inlet Water Box, Inlet Water Temperature |
| 6. To Compressor | 20. High-Pressure Cutout Load-Control Solenoids | 35. Relief Valve |
| 7. Fan Deck | 21. Discharge Isolation Valve | 36. Liquid Distribution System |
| 8. Inverter-Driven Motor | 22. Compressor | 37. Evaporator |
| 9. Fans | 23. Oil Line Shutoff Oil Filter | 38. Liquid Level Sensor |
| 10. Fan Motors | 24. TXV | 39. Outlet Water Box, Outlet Water Temperature |
| 11. Condenser Coil with Subcooler | 25. Oil Cooler (option) | 40. Evaporator Service valves |
| 12. Liquid-Line Isolation Valve | 26. Oil Pressure Transducer | |
| 13. Liquid-Line Filter | 27. Oil Temperature Sensor | |
| 14. Discharge Service Valve | 29. Oil Return Line Filter | |

Operating Principles

⚠ CAUTION

The RTAC units must only operate with R-134a and Trane OIL 00048E.

Figure 8 – RTAC Oil System

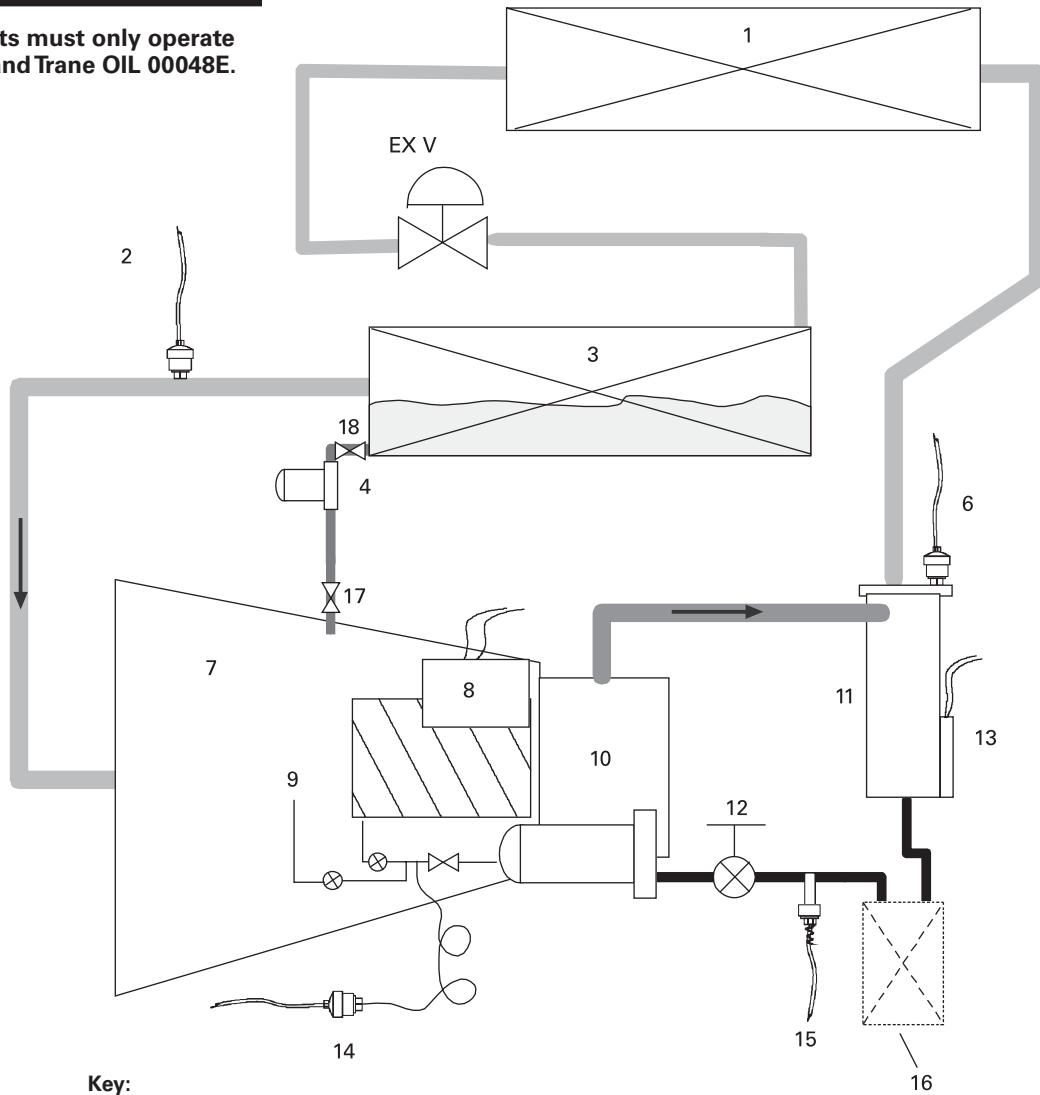

Key:

- Refrigerant with small amount of oil
- Refrigerant and oil mixture (refrigerant vapor and oil)
- Oil recovery system (liquid refrigerant and oil)
- Primary oil system

- | | |
|---|--|
| 1. Condenser | 10. Internal Compressor Oil Filter |
| 2. Evaporator Refrigerant Pressure Transducer P_E | 11. Oil Separator |
| 3. Evaporator | 12. Manual Service Valve |
| 4. Evaporator Oil-Return Line Filter | 13. Oil Separator Sump Heater |
| 6. Condenser Refrigerant Pressure Transducer P_C | 14. Intermediate Oil Pressure Transducer P_I |
| 7. Compressor | 15. Compressor Oil Temperature Sensor |
| 8. Compressor Heater | 16. Optional Oil Cooler |
| 9. Bearing and Rotor Restrictors and Oil Injection | 17. Solenoid valve (manifolded compressors only) |
| | 18. Manual service valve |

Pre-Start Checkout

Installation Checklist

Complete this checklist as the unit is installed, and verify that all recommended procedures are accomplished before the unit is started. This checklist does not replace the detailed Instructions given in the "Installation - Mechanical" and "Installation - Electrical" sections of this manual. Read both sections completely, to become familiar with the installation procedures, prior to beginning the work.

Receiving

- Verify that the unit nameplate data corresponds to the ordering information.
- Inspect the unit for shipping damage and any shortages of materials. Report any damage or shortage to the carrier.

Unit Location and Mounting

- Inspect the location desired for installation and verify adequate service-access clearances.
- Provide drainage for evaporator water.
- Remove and discard all shipping materials (cartons and so forth).
- Install optional rubber isolators, if required.
- Level the unit and secure it to the mounting surface.

Unit Piping

- Flush all unit water piping before making final connections to the unit.

⚠ CAUTION

If using an acidic, commercial flushing solution, construct a temporary bypass around the unit to prevent damage to internal components of the evaporator.

To avoid possible equipment damage, do not use untreated or improperly-treated system water.

- Connect the chilled-water piping to the evaporator.
- Install pressure gauges and shutoff valves on the chilled-water inlet and outlet to the evaporator.
- Install a water strainer in the entering chilled-water line.
- Install a balancing valve and a flow switch in the leaving chilled-water line.
- Install a drain with a shutoff valve or a drain plug on the evaporator water box.
- Vent the chilled-water system at high points in the system piping.
- Apply heat tape and insulation, as necessary, to protect all exposed piping from freeze-up.

Electrical Wiring

⚠ WARNING

To prevent injury or death, disconnect electrical power sources before completing wiring connections to the unit.

⚠ CAUTION

To avoid corrosion and overheating at terminal connections, use only copper conductors.

- Connect the unit power-supply wiring with fused-disconnect switches to the terminal block or lugs (or unit-mounted disconnect switch) in the power section of the control panel.
- Connect power-supply wiring to the chilled-water pump.
- Connect power-supply wiring to any auxiliary heat tapes.
- Connect the auxiliary contact of the chilled-water pump (6K51) in series with the flow switch, and then connect it to the proper terminals.
- For the External Auto/Stop function, install wiring from remote contacts (6S3, 6S1) to the proper terminals on the circuit board.

⚠ CAUTION

Information in Interconnecting Wiring: Chilled-Water Pump Interlock and External Auto/Stop must be adhered to or equipment damage may occur.

- If alarm- and status-relay outputs are used, install leads from the panel to the proper terminals on the circuit board.
- If the emergency stop function is used, install low-voltage leads to the terminals on the circuit board.
- Connect the External Emergency Stop, if applicable.
- If the ice-making option is used, install leads on 6S55 to the proper terminals on A6-3.
- Connect separate power supply for the ice-making status circuit, if applicable.

Pre-Start Checkout

General

When installation is complete, but prior to putting the unit into service, the following prestart procedures must be reviewed and verified correct:

⚠ CAUTION

Disconnect all electric power, including remote disconnects, before servicing. Failure to disconnect power before servicing can cause severe personal injury or death.

1. Inspect all wiring connections in the compressor power circuits (disconnects, terminal block, contactors, compressor junction box terminals and so forth) to ensure they are clean and tight.

⚠ CAUTION

Verify that all the connections are tightly made. Loose connections can cause overheating and undervoltage conditions at the compressor motor.

2. Open all refrigerant valves in the discharge, liquid, oil, and oil return lines.

⚠ CAUTION

Do not operate the unit with the compressor, oil discharge, liquid-line service valves, or the manual shutoff on the refrigerant supply to the auxiliary coolers "CLOSED." Failure to have these "OPEN" may cause serious compressor damage.

3. Check the power-supply voltage to the unit at the main-power fused-disconnect switch. Voltage must be within the voltage utilization range and also stamped on the unit nameplate. Voltage imbalance must not exceed 3%.
4. Check the unit power phasing L1-L2-L3 in the starter to ensure that it has been installed in an "A-B-C" phase sequence.

⚠ CAUTION

Improper power phasing can result in equipment damage due to reverse rotation.

⚠ CAUTION

Do not use untreated or improperly-treated water. Equipment damage may occur.

5. Fill the evaporator chilled-water circuit. Vent the system while it is being filled. Open the vents on the top of the evaporator water box while filling and close when filling is completed.

IMPORTANT

The use of improperly-treated or untreated water in this equipment may result in scaling, erosion, corrosion, algae, or slime. The services of a qualified water-treatment specialist should be engaged to determine what treatment, if any, is advisable. Trane warranty specifically excludes liability of corrosion, erosion, or deterioration of Trane equipment. Trane assumes no responsibilities for the results of the use of untreated or improperly-treated water, or saline or brackish water.

6. Close the fused-disconnect switch(es) that supplies power to the chilled-water pump starter.
7. Start the chilled-water pump to begin circulation of the water. Inspect all piping for leakage and make any necessary repairs.
8. With water circulating through the system, adjust the water flow and check the water pressure drop through the evaporator.
9. Adjust the chilled-water flow switch for proper operation.

⚠ WARNING

Use extreme caution when performing the following procedure with power applied. Failure to do so can result in personal injury or death.

10. Reapply power to complete the procedures.
11. Prove all Interlock and Interconnecting Wiring Interlock and External as described in the Electrical Installation section.
12. Check and set, as required, all CH.530 menu items.
13. Stop the chilled-water pump.
14. Energize the compressor and oil separators heaters 24 hours prior to unit startup.

Unit Voltage Power Supply

Voltage to the unit must meet the criteria given in the Installation-Electrical Section. Measure each leg of the supply voltage at the main power fused-disconnect switch for the unit. If the measured voltage on any leg is not within the specified range, notify the supplier of the power and correct the situation before operating the unit.

⚠ CAUTION

Provide adequate voltage to the unit. Failure to do so can cause control components to malfunction and shorten the life of relay contact, compressor motors and contactors.

Pre-Start Checkout

Unit Voltage Imbalance

Excessive voltage imbalance between the phases of a three-phase system can cause motors to overheat and eventually fail. The maximum allowable imbalance is 2%. Voltage imbalance is determined using the following calculations:

$$\% \text{ Imbalance} =$$

$$[(V_x - V_{ave}) \times 100 / V_{ave}]$$

$$V_{ave} = (V_1 + V_2 + V_3) / 3$$

V_x = phase with the greatest difference from V_{ave} (without regard to the sign)

For example, if the three measured voltages are 401, 410, and 417 volts, the average would be:

$$(401 + 410 + 417) / 3 = 410$$

The percentage of the imbalance is then:

$$[100(410 - 401) / 410] = 2.2\%$$

This exceeds the maximum allowable (2%) by 0.2%.

Unit Voltage Phasing

⚠ WARNING

It is imperative that L1, L2, and L3 in the starter be connected in the A-B-C phase sequence to prevent equipment damage due to reverse rotation.

It is important that proper rotation of the compressors be established before the unit is started. Proper motor rotation requires confirmation of the electrical phase sequence of the power supply. The motor is internally connected for clockwise rotation with the incoming power supply phased A-B-C.

When rotation is clockwise, the phase sequence is usually called "ABC;" when counterclockwise, "CBA."

This direction may be reversed outside the alternator by interchanging any two of the line wires. It is this possible interchange of wiring that makes a phase sequence indicator necessary if the operator is to quickly determine the phase rotation of the motor.

1. Press the STOP key on the CH.530.
2. Open the electrical disconnect or circuit protection switch that provides line power to the line-power terminal block(s) in the starter panel (or to the unit-mounted disconnect).
3. Connect the phase-sequence indicator leads to the line power terminal block as follows:

Phase Sequence Lead	Terminal
Black (Phase A)	L1
Red (Phase B)	L2
Yellow (Phase C)	L3
4. Turn power on by closing the unit supply-power fused-disconnect switch.
5. Read the phase sequence on the indicator. The "ABC" LED on the face of the phase indicator will glow if the phase is "ABC."

⚠ WARNING

To prevent injury or death due to electrocution, take extreme care when performing service procedures with electrical power energized.

6. If the "CBA" indicator glows instead, open the unit main-power disconnect and interchange two line leads on the line-power terminal block(s) (or the unit mounted disconnect). Reclose the main-power disconnect and recheck the phasing.

⚠ CAUTION

Do not interchange any load leads that are from the unit contactors or the motor terminals. Doing so may damage the equipment.

7. Reopen the unit disconnect and disconnect the phase-sequence indicator.

Water-System Flow Rates

Establish a balanced chilled-water flow through the evaporator. The flow rates should be between the minimum and maximum values given on the pressure-drop curves.

Water-System Pressure Drop

Measure the water-pressure drop through the evaporator at the field-installed pressure taps on the system water piping. Use the same gauge for each measurement. Do not include valves, strainers, or fittings in the pressure-drop readings.

CH.530 Set-up

Use of the TechView service tool is required to view and adjust most settings. Refer to the CH.530 Operation manual for instruction on adjustment of the settings.

Unit Startup Procedures

Daily Unit Startup

The time line for the sequence of operation begins with a power-up of the main power to the chiller. The sequence assumes a 2-circuit, 2-compressor, air-cooled RTAC chiller with no diagnostics or malfunctioning components. External events such as the operator placing the chiller in AUTO or STOP, chilled-water flow through the evaporator, and application of load to the chilled-water loop causing loop water-temperature increases, are depicted and the chiller responses to those events are shown, with appropriate delays noted. The effects of diagnostics, and other external interlocks other than evaporator water-flow proving, are not considered.

Note: Unless the CH.530 TechView and building automation system are controlling the chilled-water pump, the manual unit start sequence is as follows. Operator actions are noted.

General

If the prestart checkout, as discussed above, has been completed, the unit is ready to start.

1. Press the STOP key on the CH.530.
2. As necessary, adjust the set point values in the CH.530 menus using TechView.
3. Close the fused-disconnect switch for the chilled-water pump. Energize the pump(s) to start water circulation.
4. Check the service valves on the discharge line, suction line, oil line, and liquid line for each circuit. These valves must be open (backseated) before starting the compressors.

⚠ CAUTION

To prevent compressor damage, do not operate the unit until all refrigerant valves and oil-line service valves are opened.

5. Verify that the chilled-water pump runs for at least one minute after the chiller is commanded to stop (for normal chilled-water systems).
6. Press the AUTO key. If the chiller control calls for cooling, and all safety interlocks are closed, the unit will start. The compressor(s) will load and unload in response to the leaving chilled-water temperature.

After the system has been operating for approximately 30 minutes and has become stabilized, complete the remaining startup procedures, as follows:

1. Check the evaporator refrigerant pressure and the condenser refrigerant pressure under Refrigerant Report on the CH.530 TechView. The pressures are referenced to sea level (1013 mbar).
2. Check the EXV sight glasses after sufficient time has elapsed to stabilize the chiller. The refrigerant flow past the sight glasses should be clear. Bubbles in the refrigerant indicate either low refrigerant charge or excessive pressure drop in the liquid line, or an expansion valve that is stuck open. A restriction in the line can sometimes be identified by a noticeable temperature differential between the two sides of the restriction. Frost will often form on the line at this point. Proper refrigerant charges are shown in the General Information Section.

IMPORTANT

A clear sight glass alone does not mean that the system is properly charged. Also check system discharge superheat, subcooling, liquid-level control, and unit operating pressures.

3. Measure the system discharge superheat.
4. Measure the system subcooling.
5. A shortage of refrigerant is indicated if operating pressures are low and subcooling is also low. If the operating pressures, sight glass, superheat, and subcooling readings indicate a refrigerant shortage, gas-charge refrigerant into each circuit as required. With the unit running, add refrigerant vapor by connecting the charging line to the suction service valve and charging through the backseat port until operating conditions become normal.

⚠ CAUTION

If both suction and discharge pressures are low but subcooling is normal, a problem other than refrigerant shortage exists. Do not add refrigerant, as this may result in overcharging the circuit.

Use only refrigerants specified on the unit nameplate (HFC 134a) and Trane Oil 0048E. Failure to do so may cause compressor damage and improper unit operation.

Unit Startup Procedures

Seasonal Unit Startup Procedure

1. Close all valves and reinstall the drain plugs in the evaporator.
2. Service the auxiliary equipment according to the startup and maintenance instructions provided by the respective equipment manufacturers.
3. Close the vents in the evaporator chilled-water circuits.
4. Open all the valves in the evaporator chilled-water circuits.
5. Open all refrigerant valves to verify they are in the open condition.
6. If the evaporator was previously drained, vent and fill the evaporator and chilled-water circuit. When all air is removed from the system (including each pass), install the vent plugs in the evaporator water boxes.

⚠ CAUTION

Ensure that the compressor and oil-separator heaters have been operating for a minimum of 24 hours before starting. Failure to do so may result in equipment damage.

7. Check the adjustment and operation of each safety and operating control.
8. Close all disconnect switches.
9. Refer to the sequence for daily unit startup for the remainder of the seasonal startup.

System Restart After Extended Shutdown

Follow the procedures below to restart the unit after extended shutdown:

1. Verify that the liquid-line service valves, oil line, compressor discharge service valves, and optional suction service valves are open (backseated).

⚠ CAUTION

To prevent damage to the compressor, ensure that all refrigerant valves are open before starting the unit.

2. Check the oil separator oil level (see Maintenance Procedures section).
3. Fill the evaporator water circuit. Vent the system while it is being filled. Open the vent on the top of the evaporator while filling, and close it when filling is completed.

⚠ CAUTION

Do not use untreated or improperly treated water. Equipment damage may occur.

4. Close the fused-disconnect switches that provide power to the chilled-water pump.
5. Start the evaporator water pump and, while water is circulating, inspect all piping for leakage. Make any necessary repairs before starting the unit.
6. While the water is circulating, adjust the water flows and check the water pressure drops through the evaporator. Refer to "Water-System Flow Rates" and "Water-System Pressure Drop."
7. Adjust the flow switch on the evaporator piping for proper operation.
8. Stop the water pump. The unit is now ready for startup as described in "Startup Procedures."

Unit Shutdown Procedures

Temporary Shutdown and Restart

To shut the unit down for a short time, use the following procedure:

1. Press the STOP key on the CH.530. The compressors will continue to operate and, after unloading for 20 seconds, will stop when the compressor contactors de-energize.
2. Stop the water circulation by turning off the chilled-water pump after at least one minute.

To restart the unit after a temporary shutdown, enable the chilled-water pump and press the AUTO key. The unit will start normally, provided the following conditions exist:

- The CH.530 receives a call for cooling and the differential-to-start is above the set point.
- All system operating interlocks and safety circuits are satisfied.

⚠ CAUTION

Under freezing conditions, the chilled water pump must remain in operation during the full shutdown period of the chiller if the chilled water loop does not contain glycol, to prevent any risk of evaporator freeze-up. Refer to charts 1 and 2.

Extended Shutdown Procedure

The following procedure is to be followed if the system is to be taken out of service for an extended period of time, e.g., seasonal shutdown:

1. Test the unit for refrigerant leaks and repair as necessary.
2. Open the electrical disconnect switches for the chilled-water pump. Lock the switches in the "OPEN" position.

⚠ CAUTION

Lock the chilled-water pump disconnects open to prevent pump damage.

3. Close all chilled-water supply valves. Drain the water from the evaporator.
4. Open the unit main electrical disconnect and unit-mounted disconnect (if installed) and lock in the "OPEN" position.

⚠ CAUTION

Lock the disconnects in the "OPEN" position to prevent accidental startup and damage to the system when it has been set up for extended shutdown.

5. At least every three months (quarterly), check the refrigerant pressure in the unit to verify that the refrigerant charge is intact.

⚠ CAUTION

During an extended shutdown period, especially over the winter season, the evaporator must be drained of water, if the chilled water loop does not contain glycol, to prevent any risk of evaporator freeze-up.

Periodic Maintenance

General

Perform all maintenance procedures and inspections at the recommended intervals. This will prolong the life of the chiller and minimize the possibility of costly failures.

After the unit has been operating for approximately 30 minutes and the system has stabilized, check the operating conditions and complete the procedures below:

Weekly Maintenance

While the unit is running in stable conditions:

1. Check the CH.530 pressure for Evaporator, Condenser, and Intermediate Oil.
2. Observe the Liquid-Line Sight Glass on EXV.
3. If the liquid-line sight glass has bubbles, measure the subcooling entering the EXV. The subcooling should never be less than 2.2°C under any circumstances.

⚠ CAUTION

A clear sight glass alone does not mean that the system is properly charged. Also check the rest of the system operating conditions.

4. Inspect the entire system for unusual conditions and inspect the condenser coils for dirt and debris. If the coils are dirty, refer to coil cleaning.

Monthly Maintenance

1. Perform all weekly maintenance procedures.
2. Record the system subcooling.
3. Record the system superheat.
4. Make any repairs necessary.

Annual Maintenance

1. Perform all weekly and monthly procedures.
2. Check the oil sump oil level while the unit is off.

Note: Routine changing of the oil is not required. Use an oil analysis to determine the condition of the oil.

3. Have Trane or another qualified laboratory perform a compressor oil analysis to determine system moisture content and acid level. This analysis is a valuable diagnostic tool.
4. Contact a qualified service organization to leak-test the chiller, to check operating and safety controls, and to inspect electrical components for deficiencies.
5. Inspect all piping components for leakage and damage.
6. Clean and repaint any areas that show signs of corrosion.
7. Clean the condenser coils.
8. Clean the air filter located in the door of the control panel (only applicable on size 400 reduced length)

⚠ WARNING

Position all electrical disconnects in the "Open" position and lock them to prevent injury or death due to electrical shock.

9. Check and tighten all electrical connections as necessary.

Maintenance Procedures

Refrigerant Emission Control

Conservation and emission reduction can be accomplished by following recommended Trane operation, maintenance, and service procedures, with specific attention to the following:

1. Refrigerant used in any type of air-conditioning or refrigerating equipment should be recovered and/or recycled for reuse, reprocessed (reclaimed). Never release refrigerant into the atmosphere.
2. Always determine possible recycle or reclaim requirements of the recovered refrigerant before beginning recovery by any method.
3. Use approved containment vessels and safety standards. Comply with all applicable transportation standards when shipping refrigerant containers.
4. To minimize emissions while recovering refrigerant, use recycling equipment. Always attempt to use methods that will pull the lowest possible vacuum while recovering and condensing refrigerant into containment.
5. Refrigeration-system cleanup methods that use filters and dryers are preferred. Do not use solvents that have ozone depletion factors. Properly dispose of used materials.
6. Take extra care to properly maintain all service equipment that directly supports refrigeration service work, such as gauges, hoses, vacuum pumps, and recycling equipment.
7. Stay aware of unit enhancements, conversion refrigerants, compatible parts, and manufacturer's recommendations that will reduce refrigerant emissions and increase equipment operating efficiencies. Follow the manufacturer's specific guidelines for conversion of existing systems.
8. In order to assist in reducing power-generation emissions, always attempt to improve equipment performance with improved maintenance and operations that will help conserve energy resources.

Refrigerant and Oil-Charge Management

Proper oil and refrigerant charge is essential for proper unit operation, unit performance, and environmental protection. Only trained and licensed service personnel should service the chiller.

Some symptoms of a refrigerant under-charged unit:

- Low subcooling
- Bubbles in the EXV sight glass
- Low-liquid-level diagnostic

- Larger-than-normal evaporator approach temperatures (Leaving-Water Temperature - Saturated Evaporator Temperature)
- Low Evaporator-Refrigerant Temperature Limit
- Low Refrigerant-Temperature Cutout diagnostic
- Fully-open expansion valve
- Possible whistling sound coming from liquid line (due to high vapor velocity)
- Possible low discharge superheat at high loads
- High Condenser + Subcooler Pressure drop

Some symptoms of a refrigerant over-charged unit:

- High subcooling
- Evaporator Liquid Level higher than centerline after shutdown
- Larger-than-normal condenser approach temperatures (Entering-Condenser Saturated Temperature - Entering-Air Temperature)
- Condenser Pressure Limit
- High-Pressure Cutout diagnostic
- More-than-normal number of fans running
- Erratic fan control
- Higher-than-normal compressor power
- Very low discharge superheat at startup
- Compressor rattle or grinding sound at startup

Maintenance Procedures

Some symptoms of an oil over-charged unit:

- Larger-than-normal evaporator approach temperatures (Leaving-Water Temperature - Saturated-Evaporator Temperature)
- Low Evaporator-Refrigerant Temperature Limit
- Low Refrigerant-Temperature Cutout diagnostic
- Evaporator Liquid Level higher than centerline after shutdown
- Very erratic liquid-level control
- Low unit capacity
- Low discharge superheat (especially at high loads)
- Compressor rattle or grinding sound
- High oil-sump level after normal shutdown

Some symptoms of an oil under-charged unit:

- Compressor rattle or grinding sound
- Lower-than-normal pressure drop through oil system
- Seized or Welded Compressors
- Low oil-sump level after normal shutdown
- Lower-than-normal oil concentrations in the evaporator

R134a Field-Charging Procedure

Be certain that the electrical power to the unit is disconnected before performing this procedure.

⚠ WARNING

Position all electrical disconnects in the "Open" position and lock them to prevent injury or death due to electrocution.

Follow the following procedure when the unit is empty of all refrigerant and under a vacuum. Add the charge through the evaporator service valve.

⚠ CAUTION

Water must be flowing through the evaporator during the entire charging process to avoid freezing and rupturing of the evaporator tubes.

1. Note the weight of the amount of charge removed. Compare it to General Data tables. A difference in charge may indicate a leak.
2. Attach the charging hose to the evaporator service valve (3/8" [9 mm] flare). Open the service valve.
3. Add charge to the evaporator to bring the total circuit charge up to the level indicated in the above chart.
4. Close the service valve and disconnect the charging hose.

Maintenance Procedures

Adding charge:

This procedure should be followed when adding charge to an undercharged unit. When low charge is indicated by low subcooling in the liquid line, charge should be added until sufficient subcooling is achieved.

1. Attach the charging hose to the evaporator service valve (3/8" [9 mm] flare). Open the service valve.
2. Add 4.5 kg of refrigerant (R-134a) charge.
3. Close the valve, remove the charging hose and start the unit. Monitor subcooling.
4. If subcooling is still insufficient, return to step number 1.

Note: Proper subcooling can be determined from run-log history, service experience, or by contacting Trane technical service.

The service tool may include a calculation module that determines the proper subcooling for any operating condition (Trane Service only).

Charge Isolation in the high or low side of the system

(only possible with optional isolating valves)

All the refrigerant may be trapped into the high side (condenser) of the unit for maintenance on the compressor (or low side). With the suction-line service valve option, charge may also be isolated in the evaporator for maintenance on the compressor (or high side). It is much more preferable to isolate the charge in the evaporator, if this option is available.

High side charge isolation procedure:

1. Make sure the circuit is off.
2. Shut the liquid-line service valve.
3. Shut the oil return-line service valve.
4. Start the circuit with the service tool in charge-isolation mode:
 - All fans will turn on
 - EXV will open 100%
 - The oil return-line solenoid, if included, will open
 - The unit will start at minimum load
 - The unit will run until it cuts out on low pressure (~6 psia) [0.41 bar].
5. When the unit trips, the discharge check valve and the oil-line shutoff valve close.
6. Close the discharge isolation valve.
7. Close the oil-line shutoff valve.
8. Remove the remainder of the charge with the vacuum pump.

Recommendation: Do not pump the remaining charge into the high side. This may introduce non-condensable gasses and other contaminants into the unit.
9. The low side and the compressor may be serviced at this time.

Maintenance Procedures

Table 15 – Charge-Holding Capability on The High Side

Nominal Circuit Capacity (tons)	Normal Circuit Charge (kg)	*Condenser Charge-Holding Capacity at 60% full, 35°C ambient (kg)	Charge in Oil Separator (liters)	% Oil Separator Level
60	74.8	53.6	21.3	97.70%
70	74.8	53.6	21.3	97.70%
85	79.4	60.9	18.5	86.00%
100	97.5	74.3	23.3	56.00%
140	102.1	85.2	16.8	41%
170	165.6	92.3	73.3	100%
200	188.2	127.9	60.3	86.10%

*Circuit charge varies slightly with efficiency and unit configuration.

As can be seen in Table 15, when the charge is isolated on the high side, the oil separators will be flooded with refrigerant. This is because there is not enough room in the condenser to contain all the charge. For this reason, when getting the unit back to running condition, care must be taken to drive the refrigerant out of the oil separator using the oil separator heaters.

Returning the unit to running condition:

1. Open all the valves.
2. Manually open EXV for 15 minutes to allow the refrigerant to drain to the evaporator by gravity.
3. Let the unit sit with heaters on to drive refrigerant out of the oil and warm up the compressor bearings. Depending upon ambient conditions, this may take up to 24 hours.
4. After the oil level has returned to normal, the unit can be put back into operation.

Low-side charge-isolation procedure:

(only possible with optional suction isolating valves)

After normal shutdown, most of the charge resides in the evaporator. Running cold water through the evaporator may also drive much of the refrigerant to the evaporator.

1. Make sure the circuit is off.
2. Close the suction-line isolation valve.
3. Close the oil return-line service valve.
4. Close the liquid line service valve.
5. Manually open the EXV.
6. Use a liquid pump or vacuum pump to move refrigerant from the condenser to the evaporator. The liquid pump will only be

effective if there is a lot of charge in the condenser. It may be connected to the condenser drain port on the liquid-line isolation valve.

Note: if a pump is to be used, connect it before closing this valve. This port is only isolated when the valve is backseated.

If a vacuum pump is used, then connect it to the discharge-line service valve near the oil separator.

A vacuum pump will be required for part of the procedure.

The evaporator is large enough to hold all the charge, for any unit, below the centerline of the shell. Therefore, no special precautions are required to restart the unit after isolating the charge in the evaporator.

Maintenance Procedures

Filter Replacement Procedure

Refrigerant Filter-Changing Procedure

A dirty filter is indicated by a temperature gradient across the filter, corresponding to a pressure drop. If the temperature downstream of the filter is 8°F [4.4°C] lower than the upstream temperature, the filter should be replaced. A temperature drop can also indicate that the unit is undercharged. Ensure proper subcooling before taking temperature readings.

1. With the unit off, verify that the EXV is closed. Close the liquid-line isolation valve.
2. Attach the vacuum hose to the service port on the liquid-line filter flange.
3. Evacuate the refrigerant from the liquid-line and store.
4. Remove the vacuum hose.
5. Depress the Schrader valve to equalize pressure in the liquid line with atmospheric pressure.
6. Remove the bolts that retain the filter flange.
7. Remove the old filter element.
8. Inspect the replacement filter element and lubricate the o-ring with Trane OIL 0048E.
Note: Do not use mineral oil. It will contaminate the system.
9. Install the new filter element in the filter housing.
10. Inspect the flange gasket and replace it with a new one if damaged.
11. Install the flange and torque the bolts to 14-16 lb-ft [19-22 N-m].
12. Attach the vacuum hose and evacuate the liquid line.
13. Remove the vacuum hose from the liquid line and attach the charging hose.
14. Replace the stored charge in the liquid line.
15. Remove the charging hose.
16. Open the liquid-line isolation valve.

Lubrication System

The lubrication system has been designed to keep most of the oil lines filled with oil as long as there is a proper oil level in the oil sump.

The total oil charge can be removed by draining the oil system, the oil return line from the evaporator, the evaporator, and the compressor. Very small quantities of oil may be found in other components.

Maintenance Procedures

Proper charging of the oil system is critical to the reliability of the compressor and chiller. Too little oil can cause the compressor to run hot and inefficiently. When taken to an extreme, low oil level may result in instant failure of the compressor. Too much oil will result in high oil-circulation rates, which will foul the condenser and evaporator performance. This will result in inefficient operation of the chiller. Taken to an extreme, high oil levels may result in erratic expansion-valve control or shut down of the chiller due to low evaporator-refrigerant temperature. Too much oil may contribute to long-term bearing wear. Additionally, excessive compressor wear is probable when the compressor is started with the oil lines dry.

Oil system consists of the following components:

- Compressor
- Oil separator
- Discharge line with service valve
- Oil line from separator to compressor
- Oil line drain (lowest point in system)
- Oil cooler (option)
- Oil temperature sensor
- Oil line shutoff valve with flare service connection
- Oil filter (internal to compressor) with flare-fitting service connection and schrader valve
- Oil flow-control valve (internal to the compressor after the filter)
- Oil return line from evaporator with shutoff valve, oil filter, and solenoid control valve (for the manifold compressor circuits only)

The standard oil charge for each circuit size is shown in Table 16.

Figure 9 – Oil System Schematic

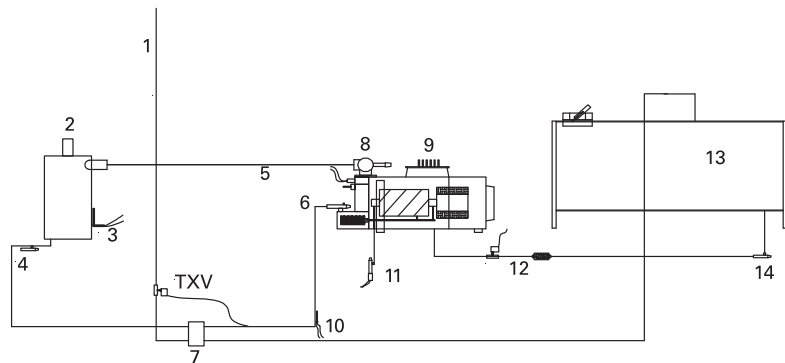

- | | |
|---|---------------------------------------|
| 1. From Subcooler | 8. Discharge Isolation Valve (option) |
| 2. Oil Separator | 9. Compressor |
| 3. Heater | 10. Oil Temperature Sensor |
| 4. Oil Drain Valve | 11. Oil Pressure Transducer |
| 5. High-Pressure Cutout Load-Control Solenoid | 12. Oil Filter |
| 6. Oil Line Shutoff Valve Oil Filter | 13. Evaporator |
| 7. Oil Cooler (option) | 14. Oil Return Line Shutoff Valve |

Figure 10 – Oil System Schematic

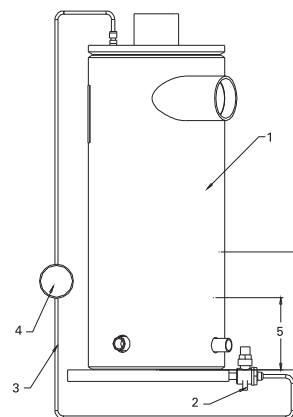

- | |
|----------------------------|
| 1. Oil separator |
| 2. Valve |
| 3. 1/4" refrigeration hose |
| 4. Sight glass |
| 5. Minimum oil level |
| 6. Maximum oil level |

Table 16 – Oil Charging Data

Circuit Tons	Oil Charge		Approximate sump oil level after running "normal" conditions		Normal quantity of oil in refrigeration system (evaporator/condenser)	
	liters	Gallons	mm	inch	lb	kg
60-70	7.6	2.0	178	7	1.1	0.5
85	7.6	2.0	152	6	1.1	0.5
100	9.9	2.6	178	7	1.8	0.8
140	17.0	4.5	203	8	3.5	1.6
170	17.0	4.5	203	8	3.5	1.6
200	19.0	4.9	203	8	3.5	1.6

Recommendation: check the oil level in the sump using a sight glass or a manometer, attached to charging hoses.

Maintenance Procedures

1. To **measure the oil level**, use the oil drain valve on the oil line and a service valve on the discharge line. This measurement can only be made when the circuit is not running. Note: the bottom plate of the oil separator is approximately 1" [25 mm] thick.
2. The initial oil charge should be approximately at the level in the above chart. This is the approximate oil level if all the oil is in the oil lines, filter, and oil sump, and the unit is in vacuum so that there is no refrigerant dissolved in the oil.
3. After the unit has run for a while, the oil level in the sump can vary greatly. However, if the unit has run "normal" conditions for a long time, the level should resemble the level in the above chart. (+1" to - 4" [25 to -101 mm] is acceptable.)

The field-charging procedure depends on the circumstances that resulted in the need for oil charge.

1. Some service procedures may result in loss of small quantities of oil that must be replaced (oil analysis, compressor filter replacement, re-tubing the evaporator, and so forth).
2. Additionally, some maintenance procedures may result in virtually all of the oil being removed (compressor motor burn or total removal of the charge to trouble shoot a unit).
3. Finally, leaks may result in a loss of oil that must be replaced.

Prelubrication

Prior to the oil charging procedure, a small amount of oil shall be injected in the port labeled "1" (Figure 11). Oil pushed into this location drains into the discharge port, which allows the oil to effectively cover the rotor end faces and rotor tips. The only issue is that if the schraeder valve is not present on this port, the 7/16 o-ring boss plug normally in this location will have to be replaced by a 7/16-schraeder fitting (Trane part number

VAL07306). If this part is not available quickly, schraeder fitting 2 or 3 (Figure 11) could be removed and put in location 1. The plug would then replace the removed schraeder fitting.

1. Add 7/16 schraeder port where plug is today. (Figure 11).
2. Pull compressor and unit into vacuum.
3. Connect oil line to port. (Figure 12).
4. Let vacuum draw in ½ liter of oil. Option: pump in ½ liter of oil. In any case, never complete the entire oil charge by this port. This could lead to drastic damages for the compressor. Oil injected should be preheated.
5. Remove oil line.

Figure 11

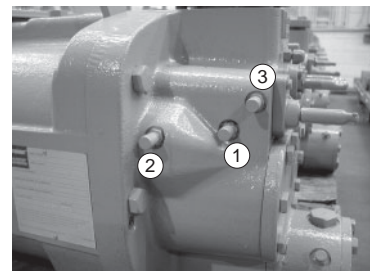
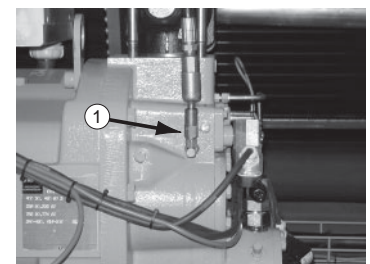

Figure 12



Maintenance Procedures

Remaining oil charge

1. Add 0.95 liter (0.90 kg) of oil to the motor cavity or suction line prior to installing the compressor into the chiller.
2. If the unit is not equipped with suction-line isolation valves, it should contain no charge. If it has isolation valves, then the charge may be trapped in the evaporator. In either case, the high side of the system should not be pressurized.
3. The oil-line shutoff valve must be open to allow the oil to pass into the oil lines and the oil separator.
4. The oil charging port is a ¼" [6 mm] flare fitting with a schrader valve that is on the side of the oil-filter housing. This is the port that must be used to add oil into the compressor so that the filter and lines are full at the first start of the compressor.
5. On single-compressor circuits, all the oil should be put into the circuit through the oil-charging port on the compressor filter housing. On two-compressor circuits, put approximately ½ of the oil into the unit through each of the two oil-charging ports on the two compressors.
6. Oil may be put into the unit using either of two methods:

- Have the unit at the same pressure as the oil. Hook up one end of the oil-charging hose to the oil charging fitting and the other end to an oil pump. Use the pump to draw oil out of the oil container and push the required amount of oil into the unit.

Note: the compressor filter has an internal shutoff valve that will prevent oil from entering the compressor while the compressor is not running. Therefore, there is no concern about flooding the compressor with oil.

⚠ CAUTION

Deduct from final charge, all charge added for prelubrication to avoid over-charging.

Field Oil-Charging Procedure

Use the initial charging procedure under the following circumstances:

- When virtually all of the oil has been removed.
- If the oil charge is removed from the compressor and oil system only, but the unit has been run for less than 15 minutes.
- If the oil charge is removed from the compressor and oil system only, and the unit has been run for more than 15 minutes. However, reduce the amount of oil added to the unit by the normal quantity of oil in the refrigeration system.

Note: this procedure can be followed even with the refrigerant charge isolated in the evaporating section of the unit.

If small quantities of oil were removed to service refrigeration components, such as the evaporator, replace the oil that was removed back into the serviced component prior to vacuum and recharge of the refrigerant.

⚠ CAUTION

Use only Trane Oil 0048E in the RTAC units to avoid any catastrophic damage to the compressor or unit.

- Have the unit in vacuum. Note that the vacuum connection should be made on the unit at the service valve that is on the discharge line. Hook up one end of the oil-charging hose to the oil-charging fitting and immerse the other end into the oil container. Let the vacuum draw the required amount of oil into the unit.

Maintenance Procedures

If oil was removed to service a compressor or change the filter follow this procedure:

1. If the compressor is a new compressor or has been removed from the system and reworked, add 0.95 liter (0.90 kg) of oil to the motor cavity prior to installing the compressor into the chiller.
2. Install the compressor in the system. Make sure that the filter shutoff valve is closed. Other compressor isolation valves may also be closed depending upon the service that was completed. For example, changing the oil filter would require the compressor to be isolated and pulled into vacuum.

Note: Ensure that the compressor is not pressurized.

3. Open the flare fitting on the oil-line shutoff valve.
4. Open the flare fitting on the filter housing. This is the port that must be used to put oil into the compressor.
5. Install one end of the charging hose on the oil charging port (with the Schrader valve) and the other on the oil canister.
6. Lift the oil canister, or use a pump, to pour oil into the filter housing.
7. When oil comes out of the flare fitting on the oil-line shutoff valve, the filter is full. Stop adding oil.
8. Put the cap on the flare on the oil-line shutoff valve, remove the charging hose, and put the cap back on the flare on the filter housing.
9. Vacuum the compressor (low side) and prepare it for inclusion in the system. There is a service valve on the suction line and on the evaporator. Use these valves to vacuum the compressor.
10. Open the oil-line shutoff valve. Severe damage to the compressor can result if the oil-line shutoff valve is closed when the compressor is started.

WARNING

Catastrophic damage to the compressor will occur if the oil-line shutoff valve or the isolation valves are left closed on unit startup.

11. Open the other compressor isolation valves.

Note: this procedure assumes that the oil that is put into the filter housing does not have contaminants such as non-condensable gases. The oil forces these gases out of the filter and oil-line shutoff valve, without the need to pull a vacuum on this small volume. If the oil has been in an open container or is otherwise contaminated, then this small volume must be subject to vacuum as well. However, the filter cavity is full of oil. Therefore, be sure to use a flash tank in line with the vacuum pump to ensure that the oil that is pulled out of the filter cavity does not slug the vacuum pump.

Notes

Notes

Notes



TRANE®

Cooling and Heating
Systems and Services



Quality Management
System Approval



LonMARK®
SPONSOR

Literature Order Number	RLC-SVX02G-E4
-------------------------	---------------

Date	0410
------	------

Supersedes	RLC-SVX02F-E4_0409
------------	--------------------

Trane has a policy of continuous product and product data improvement and reserves the right to change design and specifications without notice. Only qualified technicians should perform the installation and servicing of equipment referred to in this publication.

www.trane.com

For more information, contact your local
sales office or e-mail us at comfort@trane.com

Trane bvba
Lenneke Marelaan 6 - 1932 Sint-Stevens-Woluwe, Belgium
ON 0888.048.262 - RPR BRUSSELS